

FIRAT

**POLYETHYLENE
PRESSURE PIPE
SYSTEMS CATALOGUE**

FIRAT



CONTENTS

Introduction	02
Raw Material	06
Our Quality Understanding	08
Corporate Training	12
Environment Friendly FIRAT	13
TRNC Water Supply Project	14
Bosphorus Crossing Project	20
Libya 500 Meter Polyethylene Pipe Project	22
Polyethylene Rawaterial	26
Polyethylene Material	26
Advantages of Polyethylene Pipes	27
Characteristics of Polyethylene Rawaterial	28
PE Pipes Usage Areas	30
Lifespan Resistance PE 100 Pipes	31
Lifespan Resistance PE 80 Pipes	33
Lifespan Resistance PE 100 Pipes	35
Polyethylene Pipes and Fittings Calculation Basis	37
Water Hammer	50
Thermal Extension	51
Bending Radius	52
PE Pipes	54
PE 100 Pipes	54
PE 80 Natural Gas Pipes	56
PE 80 Pipes	57
PE 40 Pipes	58
PE Pipe Fittings	59
PE 100 EF Coupler	59
PE 100 EF Repair Adapter	60
PE 100 EF Service Tee Flat	61
PE 100 EF Service Tee With Valve	62
PE 100 EF 90° Elbow	63
PE 100 EF 45° Elbow	63
PE 100 EF Tee	64
PE 100 EF Inegal Tee	64
PE 100 End Cap	65
PE 100 EF End Cap	65
PE 100 EF Metal Transition Adapter Female	66
PE 100 EF Metal Transition Adapter Male	66
PE 100 EF Welded Steel Transition Adapter	66
PE 100 90° Elbow (Injection)	67
PE 100 90° Elbow Fabricated	67
PE 100 60° Elbow Fabricated	68
PE 100 45° Elbow (Injection)	69
PE 100 45° Elbow Fabricated	70
PE 100 30° Elbow Fabricated	71
PE 100 Equal T (Injection)	70
PE 100 Equal T Fabricated	71
PE 100 Reducing Tee (Injection)	72
PE 100 Reducing Tee (Fabricated)	73
PE 100 Inegal Tee (Injection)	74
PE 100 Inegal Tee	76
PE 100 Reduction	86
PE 100 Flange Adapter	94
PE 100 Short Type Flange Adapter	96
PE 100 Steel Flange	97
PE 100 Steel Blind Flange	98
Joining Methods of PE Pipes	99
Electrofusion Coupler Welding	100
Electrofusion Service Tee Welding	101
Butt Welding	102
Socket Fusion Welding	104
Extrusion Welding (Corner Welding)	105
Flange Joining	107
Coupling Adapter Joining	108
PE Pipe Laying Rules	109
PE Pipeline Pressure Test	110
PE Pipe Packaging and Labeling	111
PE Shipping and Stocking Rules	112
PE Resistance to Chemicals	114
Quality Assurance Test Methods	116
Standards	118
HDPE Cable Duct Pipes	120
PE Pipes Application Techniques	124
Sea Discharge Application with HDPE Pipes	124
Application of HDPE Pipe in Solid Waste Projects	125
Relining Application with HDPE Pipes	126
Potable Water Application with HDPE Pipes	127
Application of HDPE Pipes in Industrial Facilities	128
Geothermal Pipe Applications	130
Waste Water Treatment Plant Applications with HDPE Pipes	132
Natural Gas Network Applications with HDPE Pipes	133
Fish Farm Applications with HDPE Pipes	134
FIRAT Export Map	136



FIRAT

FIRAT was established to carry out production in the field of plastic building materials in the year 1972. FIRAT, which always sets out with the principles of **“Quality Production”** and **“Quality Products Diversity”**, has succeeded in becoming both the leading establishment of the sector and the export leader of the sector as a result of significant enterprises that have taken years.

In its production FIRAT targets various sectors such as construction, agriculture, automotive, medical, domestic appliances sectors with its plastic-based products. It realizes its production targeting those sectors in its modern factories in Büyükcçekmece-İstanbul and Sincan-Ankara.

FIRAT owns one of the three biggest plastic production complexes in Europe.

As of 2018 the number of personnel working in the constitution of FIRAT is 1850. Firat which believes that the most valuable element is human always organizes in-service trainings with the aim of enhancing work experience of its employees and building up their corporate knowledge.

Product Diversity and Groups

FIRAT has a product range of over 5500 products. In order to ensure that our customers get the most beneficial and satisfactory service, Firat products are manufactured as integrated systems (parts complementing each other).

Thousands of FIRAT products, such as PVC window and door frames, PVC gutters, PVC drainpipes and attachments, PVC hose assemblies, rubber and PE-based hoses, PPRC indoor installation pipes and attachments, PP composite pipes and attachments, HDPE pipes and attachments, PP&PE sheets, LDPE pipes and attachments, EF attachments, PE attachments, PE 80 natural gas pipes, PVC and PE drainage pipes, FKS sewage pipes, FCS pipe systems, tunnel type drainage pipes, double-walled cable protection pipes, EPDM gaskets, TPE gaskets, metal injection products (hinges and window fittings), PEX mobile piping system and floor heating pipes, PEX pipes and metal attachments, PEX-AL-PEX pipes, sprinkler irrigation pipes and drip irrigation pipes are at the service of customers in Turkey and many other points in the world.





FIRAT manufactures FKS canalisation pipe, the testable operating life of which is 100 years. These pipes which can be manufactured up to 2400 mm diameter from HDPE (high density polyethylene) raw material are resistant against ground motion, gnawing animals, plant roots and chemical wastes. FKS pipes are manufactured with German company Krauh technology and licence.

Triplex pipes again manufactured in FIRAT facilities are used in out door installations and grounds as well as domestic connections, predominantly in sewer line, rain water drainage lines, industrial waste water installations, water conveying pipes and drainage systems. Triplex pipe has big advantages like high flow performance, external load resistance, long operating life, transport and storage convenience, its becoming economic, endurance against chemical substances, price and maintenance convenience, imperviousness and filter-free operation choice.

FIRAT is capable of conducting welding, heavy rain and wind resistance, blow and milled blow resistance,

compression, shear and break-off strength ring rigidity (strength of FKS and Triplex pipes against soil load) tests in its the state-of-the-art test and analysis laboratories. Our products are offered to the service of our customers only after they are confirmed by the Quality Assurance Group related to their conformity to production, sale and outlet.

After all the quality control tests are completed, FIRAT products are offered to the market with Firat Quality Assurance Confirmation". Firat is the only company of the sector which holds international quality certificates such as GOST, SKZ, BDS, EMI, DVGW, TSE as well as ISO/IEC 17025 accreditation and all of the system certificates, which are ISO 14001, OHSAS 18001, ISO 10002 and ISO 9001. As an environmentally friendly manufacturer, Firat holds an ISO 14000 Environment Management System Certificate.

To develop, grow, struggle to achieve perfection through advanced technology and utilize all its resources in order to ensure long lasting customer satisfaction are the objectives of FIRAT.



FIRAT manufactures FKS sewage pipes which have a testable operating life up to 100 years. These pipes which can be manufactured up to a diameter of 3600 mm with HDPE (high density polyethylene) raw material are resistant against seismic movements, reptiles, plant roots and chemical wastes. FKS pipes are manufactured with technology and under licence of German Krah company.

Again manufactured in FIRAT facilities, Double Wall Triplex Pipes which are employed in outdoor installations and underground levels are mainly used in sewage lines and also for domestic connections, rain water drainage lines, industrial waste water installations, water conveying channels and drainage systems. Triplex Pipes have major advantages in terms of high flow performance, external load resistance, extended operating life, ease of shipping and stocking, economical, resistance to chemicals, pricing and ease of maintenance, tightness and ability to install without wastage.

Firat developed FCS pipe systems which is a new system with an operating pressure up to 10 bar to meet increasing high diameter and high operating pressure pipe demand. FCS pipe systems which ensure production of all pipes diameters at the range of 800 mm - 4000 mm have become a significant solution option for infrastructure needs with its lightweight, joining with electro-fusion welding, easy and quick installation features.

FIRAT can perform raw material analysis; source, torrent and wind strength, impact and jagged impact resistance, pressure, tensile and breaking strength, ring rigidity (resistance of FKS and Triplex pipes against

soil load) in the most advanced test and analysis laboratories in the sector. Our products are only offered to the customers upon obtaining "Quality Approval".

FIRAT products which are subject to all quality control products are offered to the market with "**FIRAT Quality Assurance Certification**".

FIRAT is the only company in the sector who holds international quality certifications such as RAL, GOST, SKZ, BDS, SABS, EMI, DVGW, VDE, TSE and also all ISO 14001, OHSAS 18001, ISO 10002 ve ISO 9001 system certifications. Firat holds ISO 14001 Environment Management System certificate as an environmentally friendly manufacturer.

Products of FIRAT achieved customer satisfaction in more than 60 countries and got the standing they deserved.

FIRAT aims to utilize all of its resources, advance, grow and catch perfection and excellence with advanced technology for ensuring continuous customer satisfaction.

In line with the goals of perfectionism and excellence of FIRAT, our products are largely preferred due to features of reliability, ease of accessibility and after-sales support.





FIRAT Administrative Building



Raw Material

Polyethylene

Polyethylene is a thermoplastic which is used in numerous products. Its name comes from ethylene in monomer state. Polyethylene is produced by using ethylene. It is generally referred to as PE briefly in plastics industry. Ethylene molecule C_2H_4 , actually consists of two CH_2 which are bound with double bond. Production of $(C_2=CH_2)$ is realized through polymerization of ethylene. Polymerization is a reaction starting from monomer units and resulting in polymer units.

HDPE

HDPE is a high density polyethylene material obtained from petroleum, it is the abbreviation of "High Density Polyethylene". It is generally addressed in the industry and manufacturing sector with this name.

Raw Material Tests

- Density Test
- Melting Flow Rate (MFR) Test
- Elongation at break Test
- OIT Thermal Stability Test
- Pigment Dispersion Test
- Carbon Black Content Test
- Particulate Size Test
- Viscosity and K Number Evaluation Test
- Cross-Link Degree Test
- Moisture Determination Test



Features

High density class of polyethylene is named as HDPE. HDPE has a high resistance against water and chemicals. HDPE has very good mechanical attributes, particularly, it has a high resistance to impact and tensile strength. It is a material which is suitable for numerous forming methods such as injection, extrusion, powder coating, film coating and rotational molding.

Areas of use

Having an extensive area of use, HDPE is used in pressure and non-pressure pipe manufacture, in gas distribution systems, manufacture of electrical and electronic goods. Since it is resistant to water, HDPE is also used in building boats, water tanks and floats.



Our Quality Understanding

Quality control process in FIRAT laboratories consists of three stages.

1. Input Quality Control
2. Process Quality Control
3. Output-Final Quality Control

Input Quality Control

All kinds of raw materials and auxiliary materials supplied from our suppliers are subject to Input Quality Control tests according to the “quality-production” standards determined by FIRAT. Samples taken from each lot of raw materials and auxiliary materials delivered in lots by our suppliers in compliance with “acceptance sampling” standard are required to pass physical suitability, chemical suitability, density, MFI, humidity, bulk density, viscosity, grain thickness distribution, “K” number tests at Input Quality Control Laboratories and have “Suitable for Production” approval.

Process Quality Control

During production process which is carried out by using raw materials and auxiliary materials that have “Suitable

for Production” approval, samples taken from production lines during production stage and right after production are subjected to Process Quality Control tests which are determined by (TSE) and international (DVGW, SKZ, EN, DIN, etc.) standards institutions at the laboratories of FIRAT.

Main Process Quality Control tests are as follows:

- Pressure Test
- Density Test
- Melting Flow Rate (MFR) Test
- Elongation at break Test
- Oxygen Induction Time Test
- Pigment Distribution Test
- Carbon Black Content Test
- Particle Size Test
- K Number Evaluation Test
- Cross-Link Degree Test
- Ring Stiffness Test
- Rapid Crack Propagation Test

Quality Tests



Pressure Test



Density Test



Melting Flow Rate (MFR) Test



Carbon Black Content Test



Particle Size Test



K Number Evaluation Test

During Process Quality Control stage, diameter, wall thickness and ovality measurements are performed simultaneously with the production with full automation using ultrasonic measurement devices installed on all production lines, faulty production is avoided with the sound and light warning system which is activated in out-of-standard conditions. Our products are required to get **“Quality Approval”** upon passing all tests carried out in control frequencies and quantities specified in the standards.

All of our products are subject to quality and hygiene suitability tests with samples taken from our production lines semi-annually and regularly by the representatives of international test and certification institutions such as DVGW, SKZ, SKZ, SABS etc. in addition to the quality control tests performed at the laboratories of FIRAT. Our products which pass these tests and satisfy the required quality conditions are offered to our customers.

Output-Final Quality Control

Our products with quality approval are subject to Packaging Suitability, Package Suitability, Identification and Label Suitability checks and are required to obtain **“Suitable for Shipping”** approval upon packaging and packing phases.

***FIRAT owns Turkey’s first and only TÜRKAK accredited quality, control and test laboratory.**



Elongation at Break Test



Oxygen Induction Time Test

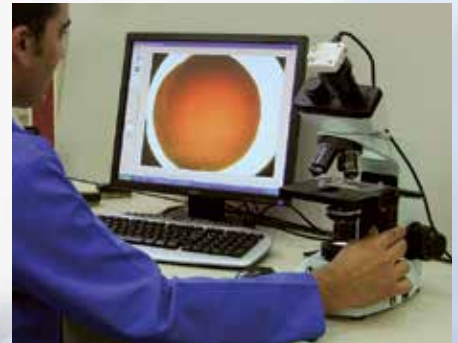

Pigment Dispersion Test



Cross-Link Degree Test



Ring Stiffness Test











Rapid Crack Propagation Test

Our Quality Certificates



POLYETHYLENE Pipes and Fittings hold nationally and internationally recognized quality certificates and reports issued by third party inspection bodies.

-  • TSE - Turkish Standards Institution (Turkey)
-  • DVGW (Germany)
-  • SKZ (Germany)
-  • SABS (South Africa)
-  • BDS (Bulgaria)
-  • EMI (Hungary)
-  • GOST (Ukraine)
-  • AVIZ TEHNIC (Romania)
-  • GOST (Russia)

Corporate Training

Adopting the understanding of **“The most valuable asset is human”**, FIRAT invests in human. FIRAT offers various trainings to its employees both for improving their work professional performance and to increase their corporate information background, internally in regular intervals and also enables them to participate in required trainings, seminars and congresses both at home and abroad.

FIRAT has become the leader of the sector also in terms of training by communicating the targeted results openly and clearly with its employees to ensure that they enjoy their jobs, they perform productively and become contributive and through offering all kinds of work, training and organization facilities to its employees and acting as a **“team”** altogether and in integration.

Considering the issue of progressing by using knowledge in the trainings, FIRAT adopts to utilize knowledge and technology in production and after sales services with its inquisitive, problem solving, result focused employees and to ensure customer satisfaction through employee and dealer trainings that are offered regularly.



FIRAT, ISO Standard preparation meeting.



Environment Friendly FIRAT

Producing by the use of “**Environmental Friendly Production Technologies**” since its foundation, FIRAT proves its sensitivity toward environmental health through its **Environmental Management System** established in 2002 and considers this area as a “**Window of Management**”.

Upon obtaining TS EN ISO 14001 2004 “**Environment Management System**” certificate from SGS in 2003, FIRAT had its sensitivity toward environmental health confirmed in national and international setting.

FIRAT not only retains its established environmental consciousness within its organization but also transforms this consciousness into an environmental policy and shares it with its neighbors, suppliers and customers. Especially during domestic and foreign seminars held for its end-users, FIRAT shares its efforts made toward environmental problems and importance that should be attached to the environmental health primarily with its business partners.

95% of the products of FIRAT consists of re-cycled re-processable materials. It sends its non-household wastes and non-recyclable waste products to “**Disposal Facilities**” licensed by the Rep. of Turkey, Ministry of Environment and Forests and implements recycling process in these facilities.

Environment Management Programs and Projects oriented to Environmental Health Protection drawn up by the Environmental Group consisting of our environmental engineers are being realized within FIRAT organization.

Committing its compliance with all national and international Environmental Legislative Directives and Environmental Regulations, FIRAT fulfills all its legal liabilities and declares statutory assessment reports to the relevant Ministry.

FIRAT , awarded by ISO (Istanbul Chamber of Industry) with “**Environment Incentive Reward**” with its environmental project drawn up in 2011, always gives precedence to the importance of environmental health and shows necessary sensitivity in all its investments.





FIRAT signed

CYPRUS WATER

1600 mm DIAMETER! 500 meters monolithic,



PROJECT FILM

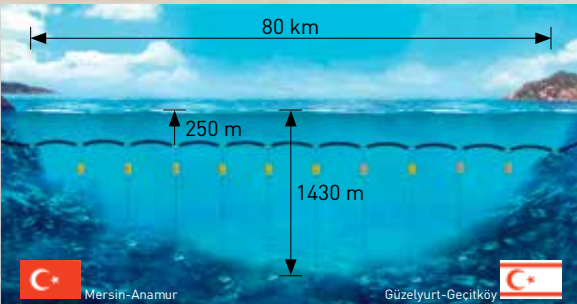

Diameter : 1600 mm
 Class : HDPE PE 100 LS (LOW SAGGING)
 Pressure : PN 6,4 (SDR 26) / PN 8 (SDR21)
 Pipe Length : 500 m x 160 piece
 500 m Pipe Weigth : 148 ton
 Raw Metarial Weigth : 25.000 ton

history!

YEARNING IS OVER!

a total length of 80,000 meters.



Turkish Republic of Northern Cyprus

Water Supply Project

One More Breakthrough from Firat!

Almost whole water need of TRNC with limited aboveground water sources is catered via underground water resources. The quality of available water lowers due to mixing of polluted underground water with drinking water because of the landfills near the clean water sources and the potential of the limited water decreases day by day.

The Republic of Turkey, Ministry of Forestry and Hydraulic Works has developed many projects up to now to cater the water need of TRNC, which is short of water, however considering that the most proper method for a long-lasting solution would be a water line to be installed from Turkey to TRNC, the "TRNC Drinking Water Supply Project" has been implemented. With this project, the water taken from Alaköprü Dam built in Turkey is being transferred to Geçitköy be built in TRNC through a pipeline under the sea. The most critical part of this giant project which consists of three pillars as Turkey, sea passage and TRNC.

With its successful projects recorded in the world plastics literature, high engineering knowledge, experience, production capacity and speed in PE Pipe Production, FIRAT surpassed the major companies of the world, which manufacture 500-m massive HDPE Pipe, and became the pipe manufacturer of TRNC Drinking Water Supply Project.



50-Year Water Need to be Catered!

FIRAT has built a production facility with three big PE 100 pipe extrusion lines on an area of 85.000 m², including 5.500 m² of indoor area at Mersin-Taşucu Seka Harbor site in order to manufacture PE 100 pipes to be used for 80 km line in such a short time like as one year.

PE100 pipeline planned to be built with "TRNC Drinking Water Supply Project" features a first in the world with its sea passageway in the length of 80.151 m and with the particularity to be fixed on the hanger in 250 meters depth. In the project, in which totally 160 pipes, are manufacture which have 1600 mm diameter, and are 500 m in massive length and have a pressure of PN 8 and PN 6,4 bar, 25,000 tons of raw material are used in total.

Production of the pipes were completed on January 14 th, 2014 this giant project allows 75 million m³ water to flow into TRNC annually and TRNC now has a resource that meets its 50 year water need.

In addition to drinking, usage and industrial purposes, this resource, which is also used for irrigation purposes, ensures zv farming on 4.824 hectare area, thereby contributing to the regional economic development.

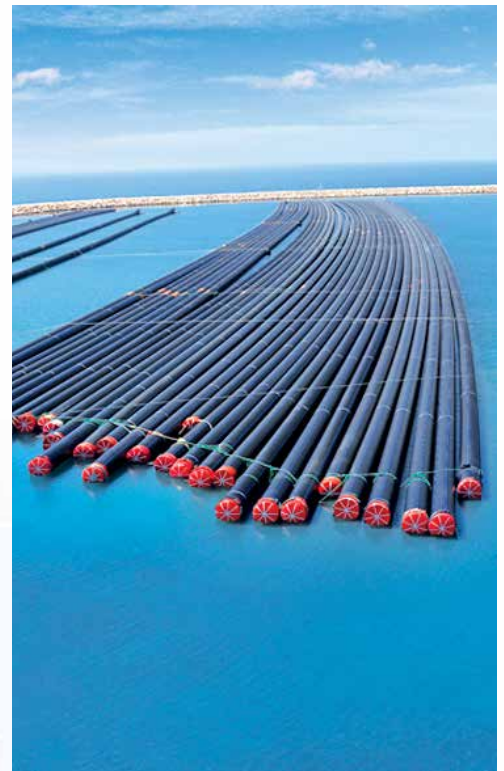

We broke a world record!

WE PRODUCED THE WORLD'S THICKEST PE PIPE!

Ø 1200x109,1 mm
PN16



PROJECT FILM

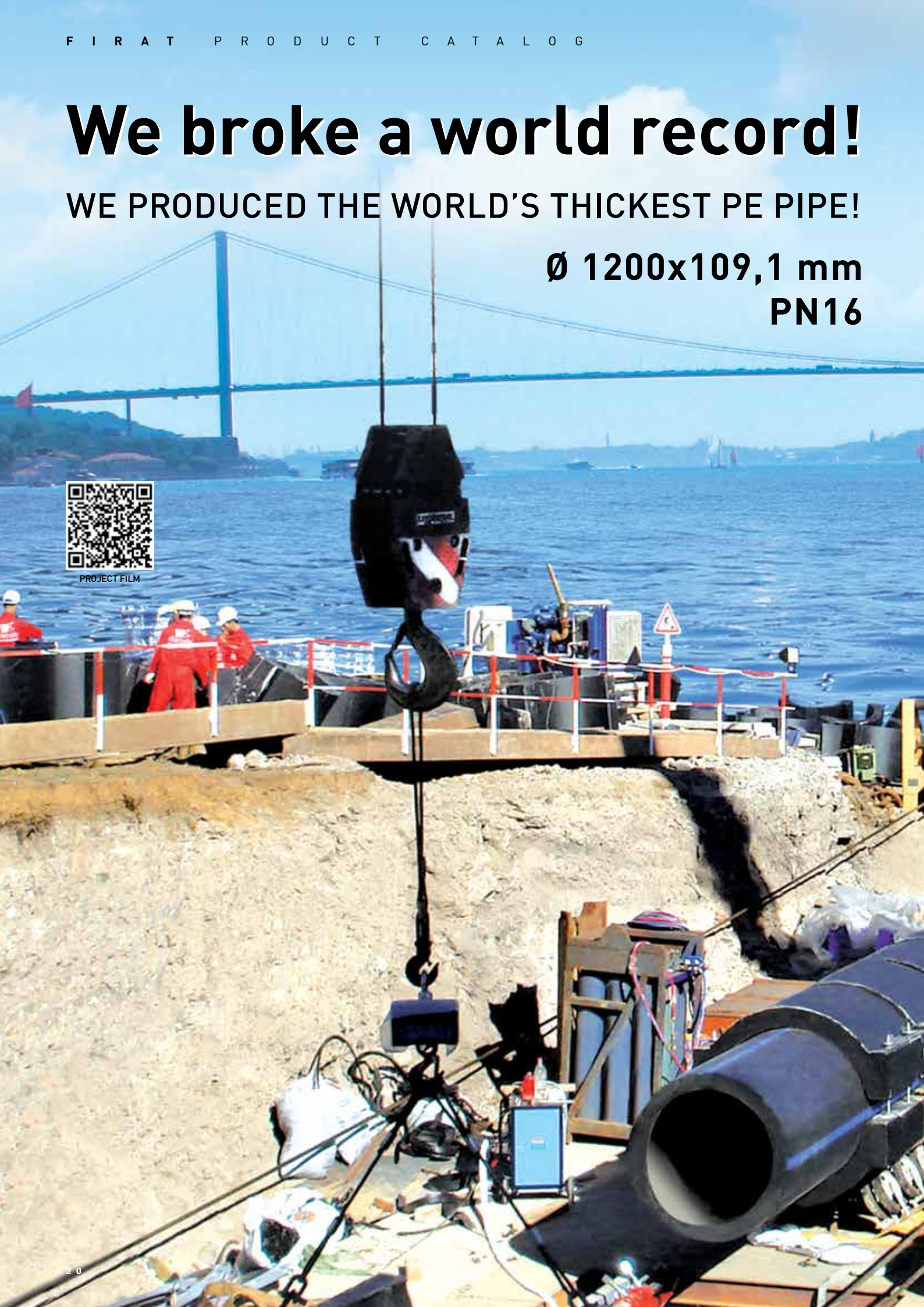



Bosphorus Crossing Project

We broke the world record in Istanbul Bosphorus!

We Broke a World Record at the Bosphorus!

Produced specially by FIRAT as the first time in the world, PE 100 pipes with 16 bar operating pressure resistance and 1200 mm diameter were installed crossing the Bosphorus with the project implemented by İSKİ in 2007 summer to prevent water shortage and to meet the water demand on Asian - European sides in a balanced way. Potable water conveyed to Ömerli Dam from Melen river by İSKİ were conveyed through world's thickest PE pipes manufactured by FIRAT with a diameter of 1200 mm between Salacak-Sarayburnu on the sea bottom. PE pipes with 1200 mm diameter and 16 bar operating pressure resistance were manufactured from 3rd generation LS Class Polyethylene 100 raw material developed specially for "Bosphorus Crossing Project" which is directed to İSKİ's Yenikapı Facilities from here and pumps 300.000 cubic meters additional water daily to European side. Wall thickness of the pipes is 109.1 millimeter as the highest wall thickness produced in the world for such diameter.



We produced the world's thickest PE pipe!

We Manufactured the Thickest PE Pipe in the World!

In this project; pipes were anchored to the sea bottom with concrete blocks installed on the piping. Each of the pipes used in the project is 13 meters long and weighs 5 tons. With a total project length of 4,000 meters, PE pipes were manufactured in Büyükçekmece Facilities of Fırat by the experienced engineers and workers. PE pipes were shipped to İSKİ - Sarayburnu worksite by land and they were joined with "butt welding" method by engineers and technicians of Fırat at the worksite. Pipes were laid on the bottom of Bosphorus as two lines between Sarayburnu - Salacak. Laying of pipes to the Bosphorus was realized with "sea bottom laying method" carried out with vessels. PE 100 Pipes were anchored to the bottom of the Bosphorus with concrete rings. With the thickest PE pipes in the world major savings were realized in terms of time and cost for İSKİ's "the Bosphorus Crossing Project".



We broke down the



PROJECT.FILM



world monopoly!

Firat, having broken the world monopoly by producing a PE 100 pipe, withstanding a pressure of 16 bars, with 1200mm diameter and 109.1 mm wall thickness, to be used within the scope of “Bosporus Crossing Project”, and carrying water to the European side of Istanbul, has created another “first” in its country by producing a 500m long pipe.



Libya Sea Water Desalination Project

Firat Broke Down the World Monopoly!

Firat Plastik broke new grounds in its country and manufactured 500 meters long single piece polyethylene pipe. PE 100 pipes used for supplying potable water to the city network from sea water treatment facilities in Libya have a diameter of 1400 mm and wall thickness of 55 mm. Each pipe which is resistant to 6.4 bar operating pressure is 500 meters long and weighs 110 tons. Total length of 3000 meters was achieved with pipes which are manufactured in quantity of 6.

Thanks to single piece PE 100 pipes which have a length of 500 meters preferred for minimizing the hydraulic pressure loss and requiring less joints; lines are installed in a lot shorter time.



500 meters long PE 100 Pipe is manufactured!

Since the pipes manufactured for this project are required to be shipped by floating on the sea, we established a mobile production plant on Büyükçekmece coast in a short time as low as 15 days with challenging efforts of our engineers and workers. PE pipes which we manufactured in 30 days were delivered to the sea with the conveyor wheels developed by our R&D department for this task.

Çanakkale Strait Crossing

6 pieces of 500 meters long PE pipes were shipped to Libya from Büyükçekmece coast by floating. Dardanelles Strait was closed to marine traffic for safety purposes.



Polyethylene Rawmaterial

Advancements in the technology ensured that important advancements were also realized in plastic raw material production. Low density polyethylene (PE 32-LDPE) which was developed in 1950's was firstly used for potable water piping. Later, with the development of PE 63 raw material, application in systems which do not require high pressure was realized successfully. However, it was only possible to use PE 63 in natural gas systems which require low pressure (maximum 4 bars) due to its technical properties. PE manufacturers launched PE 80 raw material as 2nd generation after PE 63. Thus, it was possible to use PE 80 raw material in potable water and natural gas networks with high performance. 3rd generation PE 100 raw material which was developed in the beginning of 1990s offered higher performance and an economical solution for potable water, utility water and natural gas networks.

First potable water applications with HDPE pipes have commenced in America and Canada following 1960s and projects executed at those dates are still operating without any problems.

1. Generation raw materials;

PE 32 (LDPE), PE 40 (MDPE), PE 63 (HDPE)

2. Generation raw materials;

PE 80 (MDPE), PE 80 (HDPE)

3. Generation raw materials;

PE 100 (HDPE)

FIRAT PLASTİK A.Ş. manufactures PE 100 pipes between diameters of Ø 20 - Ø 2500 mm, PE 80 natural gas pipes between diameters of Ø 20 - Ø 630 mm and PE 40 MDPE potable water pipes between diameters of Ø 20 - Ø 110 mm.

PE pipes are produced in coils up to Ø 125 mm, diameters equal to 125 mm and higher are produced in 12 m length, additionally, custom productions can be carried out.



Advantages of Polyethylene Piping

- They have high flexibility features. Thus, they ensure ease of installation. Elongation at break is minimum 350%.
- They are not affected from underground movements, they do not break.
- They have high impact resistance and rapid crack propagation resistance.
- Since they have low interior surface roughness, they ensure significant advantages while selecting diameter during project design.
- They are suitable for installing on sea bottom, they are not affected from sea water and sea movements.
- They do not have installation wastage thanks to the joining method.
- Black colored pipes are resistant to UV rays.
- They are not affected from harmful substances which are contained in the structure of soil that cause abrasive effects. Therefore, cathode protection is not required.
- They are resistant to chemical substances.
- They do not change odor and taste of water, therefore, fit for health.
- It is not possible for plant and tree roots to penetrate inside the pipes.



Characteristics of Polyethylene Raw Material

Raw materials used in production of polyethylene pipe and fittings are classified with MRS (Minimum Required Strength). MRS, is the value of strength that the material has against inner pressure for 50 years under 20°C.

PE materials are classified according to MRS as specified in table 1.

Safety coefficient is determined according to the class of the raw material and condition of the network in PE pipe networks and all calculations are made according to this coefficient. Safety coefficient is taken C=2.0 in natural gas networks and C=1.25 in potable water distribution lines. Mechanical strength values of PE materials increase with the higher density. When a pipe with the same operating pressure is manufactured from different raw materials, decrease in the wall thickness is realized as follows.

In the case a pipe with an Outer diameter of 110 mm and operating pressure of 10 bar is made of PE 32, PE 63, PE 80 and PE 100 raw materials, wall thicknesses and weights will be according to the following data.

Table 1
MRS Classification

Raw Material Class	MRS (MPa) Value
PE 40	4.0
PE 63	6.3
PE 80	8.0
PE 100	10

Table 2
C Coefficient Classification

Material Type	C Minimum
PB	1,25
PE	1,25
PP	1,6
PVC	2,0

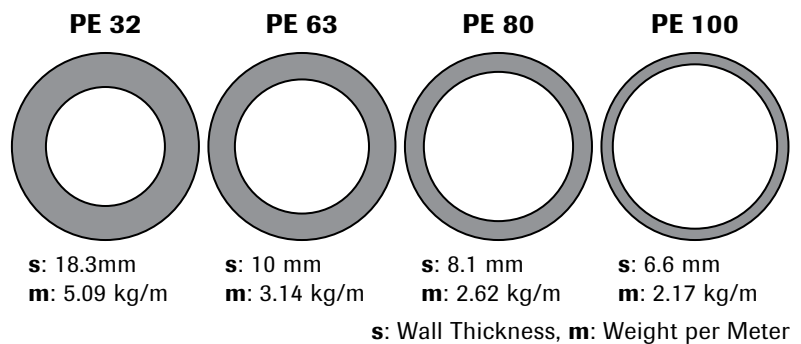

PE 100 Ø 1200 mm PN 16 pipe wall thickness, s:109.1 mm

PN, S SDR Value Table for HDPE Pipes Material Class (MRS) under 20°C

Standard Dimensional Ratio SDR	Pipe Series S	PN (Bar) Material Class		
		PE 40	PE 80	PE 100
41	20		3.2	4
33	16		4	5
26	12.5	2.5	5	6
22	10.5		6	
21	10	3.2	6.3	8
17	8	4	8	10
13.6	6.3	5	10	12.5
11	5		12.5	16
9	4	8	16	20
7.4	3.2	10	20	25
6	2.5		25	32

S= Pipe Series = (SDR-1)/2 SDR= Outer Diameter / Wall Thickness PN: Nominal Pressure

Raw Material Properties of PE Pipes

	Unit	Test Method	PE 40	PE 80	PE 80	PE 100	
Polymer Data	Color		black	yellow	black	black/bluue	
	Density (23°C'de	g / cm ³	ISO 1183	≥ 0.930	≥ 0.930	≥ 0.940	≥ 0.940
	MFR (190°C/5Kg)	g / 10 dk.	ISO 1133	-	0.8-1.3	0.4-0.7	0.16-0.7
Mechanical Properties	Elongation Break	%	ISO 527	≥ %350	≥ %350	≥ %350	≥ %350
	Elasticity Module	MPa	ISO 527	≥ 500	≥ 700	≥ 700	≥ 1000
Other Features	Oxidation Induction Time	dk.	EN 728	≥ 20	≥ 20	≥ 20	≥ 20
	Carbon Black Content	%	ISO 6964	-	-	2-2.5	2-2.5
	Carbon Black Dispersion	Nominal	ISO 18553	-	-	max 3	max 3

*Data concerning carbon black quantity and dispersion are only applicable for black pipes.



PE 100 ø 1,200 mm PN 16 pipe wall thickness, s: 109.1 mm.

PE Pipes Usage Areas

PE Pipes Usage Areas	PE 40 LDPE	PE 63 HDPE	PE 80 MDPE	PE 80 HDPE	PE 100 HDPE
Potable water pipelines		•	•	•	•
Pressure irrigation pipelines		•	•	•	•
Main network subscriber connection application	•	•	•	•	•
Hydroelectric Power Plants					•
Gas lines			•	•	•
Treatment plant pipeline			•	•	•
Water treatment installation			•	•	•
Swimming pools pipeline			•	•	•
Chilled water pipeline			•	•	•
Compressed air lines	•	•	•	•	•
Solid material conveying lines		•	•	•	•
Chemical substances pipeline			•	•	•
Geothermal Jacketing heating pipes			•	•	•
Cable Duct pipe			•		
Sewage pipelines			•	•	
Solid waste methane gas discharge line			•	•	•
Solid waste drainage line			•	•	
Sea discharge application			•	•	•
Fish farm application		•	•	•	



Lifespan Resistance

PE 100 Pipes

PE 100 Pipes Pressure-Temperature-Lifespan Table

TEMPERATURE (°C)	OPERATING PERIOD (YEAR)	SDR								
		41	33	21	17	13.6	11	9	7.4	6
		PIPE SERIES S								
		20	16	10	8	6.3	5	4	3.2	2.5
PN										
OPERATING PRESSURE (BAR)										
		4	5	8	10	12.5	16	20	25	32
10	5	5.00	6.30	10.1	12.6	15.7	20.2	25.2	31.5	40.4
	10	4.90	6.20	9.90	12.4	15.5	19.8	24.8	31.0	39.7
	25	4.80	6.00	9.60	12.1	15.1	19.3	24.2	30.2	38.7
	50	4.70	5.90	9.50	11.9	14.8	19.0	23.8	29.7	38.0
	100	4.60	5.80	9.30	11.6	14.6	18.7	23.3	29.2	37.4
10	5	4.20	5.30	8.40	10.6	13.2	16.9	21.2	26.5	33.9
	10	4.10	5.20	8.30	10.4	13.0	16.6	20.8	26.0	33.3
	25	4.00	5.00	8.10	10.1	12.7	16.2	20.3	25.4	32.5
	50	4.00	5.00	8.00	10.0	12.5	16.0	20.0	25.0	32.0
	100	3.90	4.90	7.80	9.80	12.2	15.7	19.6	24.5	31.4
30	5	3.60	4.50	7.20	9.00	11.2	14.4	18.0	22.5	28.8
	10	3.50	4.40	7.00	8.80	11.0	14.1	17.7	22.1	28.3
	25	3.40	4.30	6.90	8.60	10.8	13.8	17.2	21.6	27.6
	50	3.30	4.20	6.70	8.40	10.6	13.5	16.9	21.2	27.1
40	5	3.00	3.80	6.10	7.70	9.60	12.3	15.4	19.3	24.7
	10	3.00	3.80	6.00	7.60	9.50	12.1	15.2	19.0	24.3
	25	2.90	3.70	5.90	7.40	9.20	11.8	14.8	18.5	23.7
	50	2.90	3.60	5.80	7.20	9.10	11.6	14.5	18.2	23.3
50	5	2.60	3.30	5.30	6.70	8.30	10.7	13.4	16.7	21.4
	10	2.60	3.20	5.20	6.50	8.10	10.4	13.0	16.2	20.3
	15	2.30	2.90	4.70	5.90	7.40	9.50	11.8	14.8	19.0
60	5	1.90	2.40	3.80	4.80	6.00	7.70	9.70	21.1	15.5
70	2	1.50	1.50	3.10	3.90	4.90	6.20	7.80	9.80	12.5

Pressure Reduction Coefficients Dependent to Temperature

PE pipe system is designed for 20° C. Maximum operating temperature is 40°C. However, in the case of operation in excess of 20°C, coefficients on the right hand side can be used for pipe selection.

Interpolation can be performed for intermediate temperatures. Admissible operating pressure (PFA) is calculated using the following equation.

$$PFA = f_T \times f_A \times PN$$

Temperature (°C) Coefficient (f_T)

20	1,00
30	0,87
40	0,74

f_T : Pressure Reduction Coefficient

f_A : Dependent on Application (Conveying water f_A=1),
Reduction factor (or Increment factor)

PN: Nominal Pressure

PE 100 Pipes

PE 100 Pipes Lifespan Table Dependent to Temperature

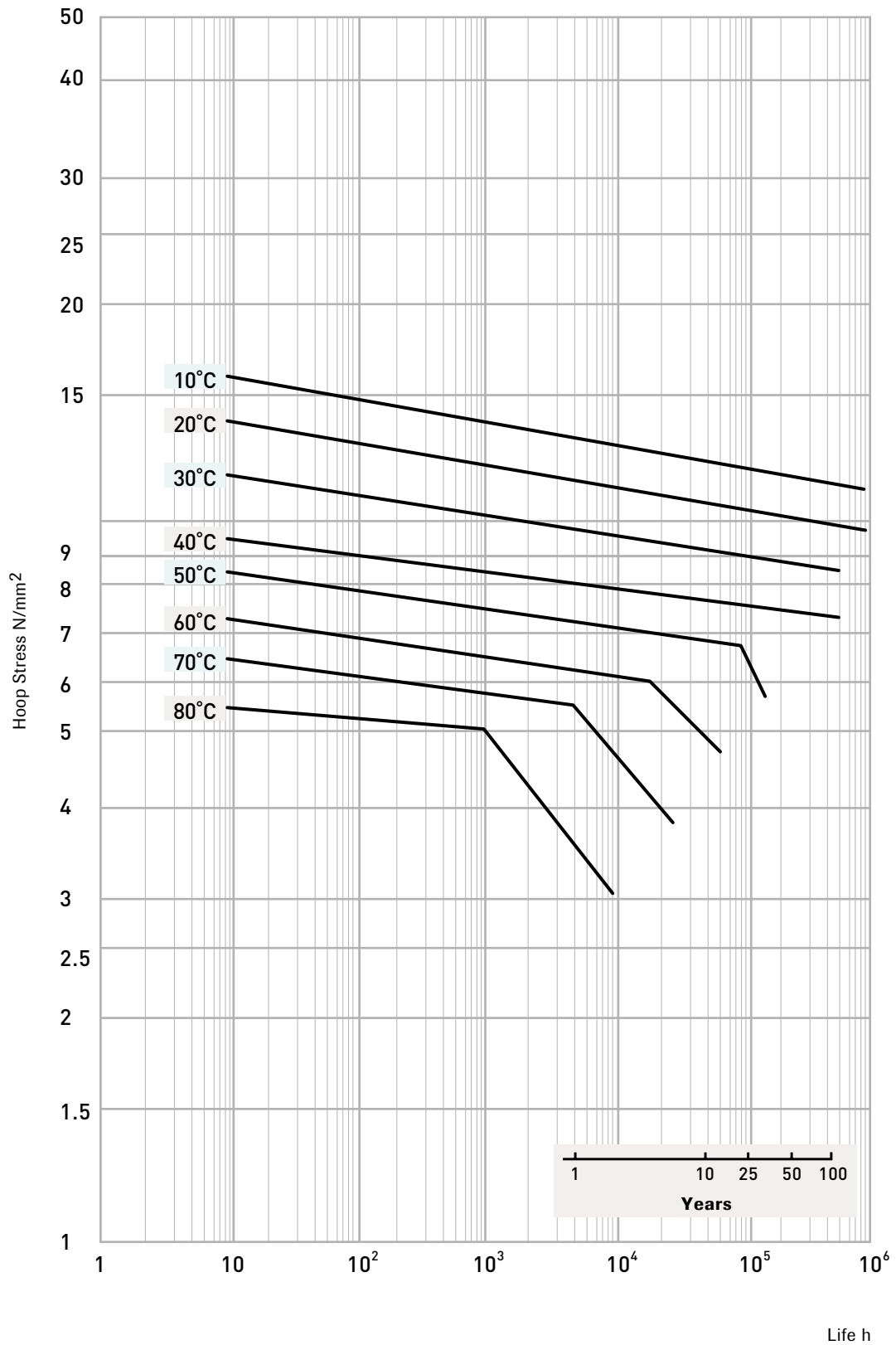

PE 80 Pipes

PE 80 Pipes Pressure-Temperature-Lifespan Table

TEMPERATURE (°C)	OPERATING PERIOD (YEAR)	SDR								
		41	26	22	17	13.6	11	9	7.4	6
		PIPE SERIES S								
		20	12.5	10.5	8	6.3	5	4	3.2	2.5
PN										
OPERATING PRESSURE (BAR)										
10	5	4.00	6.30	7.50	10.1	12.6	15.8	20.2	25.3	31.6
	10	3.90	6.20	7.40	9.90	12.4	15.5	19.8	24.8	31.0
	25	3.80	6.00	7.20	9.70	12.1	15.1	19.4	24.2	30.3
	50	3.80	5.90	7.10	9.50	11.9	14.8	19.0	23.8	29.7
	100	3.70	5.80	7.00	9.30	11.6	14.6	18.7	23.3	29.2
10	5	3.40	5.30	6.30	8.50	10.6	13.2	17.0	21.2	26.5
	10	3.30	5.20	6.20	8.30	10.4	13.0	16.7	20.8	26.0
	25	3.20	5.00	6.10	8.10	10.1	12.7	16.2	20.3	25.4
	50	3.20	5.00	6.00	8.00	10.0	12.5	16.0	20.0	25.0
	100	3.10	4.90	5.80	7.80	9.80	12.2	15.7	19.6	24.5
30	5	2.80	4.50	5.40	7.20	9.00	11.2	14.4	18.0	22.5
	10	2.80	4.40	5.30	7.00	8.80	11.0	14.1	17.7	22.1
	25	2.70	4.30	5.10	6.90	8.60	10.8	13.8	17.3	21.6
	50	2.70	4.20	5.00	6.70	8.40	10.6	13.5	16.9	21.2
40	5	2.40	3.80	4.60	6.20	7.70	9.60	12.4	15.5	19.3
	10	2.40	3.80	4.50	6.00	7.60	9.50	12.1	15.2	19.0
	25	2.30	3.70	4.40	5.90	7.40	9.20	11.8	14.8	18.5
	50	2.30	3.60	4.30	5.80	7.20	9.10	11.6	14.5	18.2
50	5	2.10	3.30	4.00	5.30	6.70	8.40	10.7	13.4	16.8
	10	2.00	3.20	3.80	5.10	6.40	8.10	10.3	12.9	16.2
	15	1.80	2.80	3.40	4.50	5.70	7.10	9.10	11.4	14.3
60	5	1.40	2.20	2.70	3.60	4.50	5.60	7.20	9.00	11.3
70	2	1.10	1.70	2.00	2.70	3.40	4.30	5.50	6.90	8.70

Pressure Reduction Coefficients Dependent to Temperature

PE pipe system is designed for 20° C. Maximum operating temperature is 40°C. However, in the case of operation in excess of 20°C, coefficients on the right hand side can be used for pipe selection.

Interpolation can be performed for intermediate temperatures. Admissible operating pressure (PFA) is calculated using the following equation.

$$PFA = fT \times fA \times PN$$

Temperature (°C) Coefficient (f_T)

20	1,00
30	0,87
40	0,74

f_T : Pressure Reduction Coefficient

f_A : Dependent on Application (Conveying water f_A=1),
Reduction factor (or Increment factor)

PN: Nominal Pressure

PE 80 Borular

PE 80 Pipes Lifespan Table Dependent to Temperature

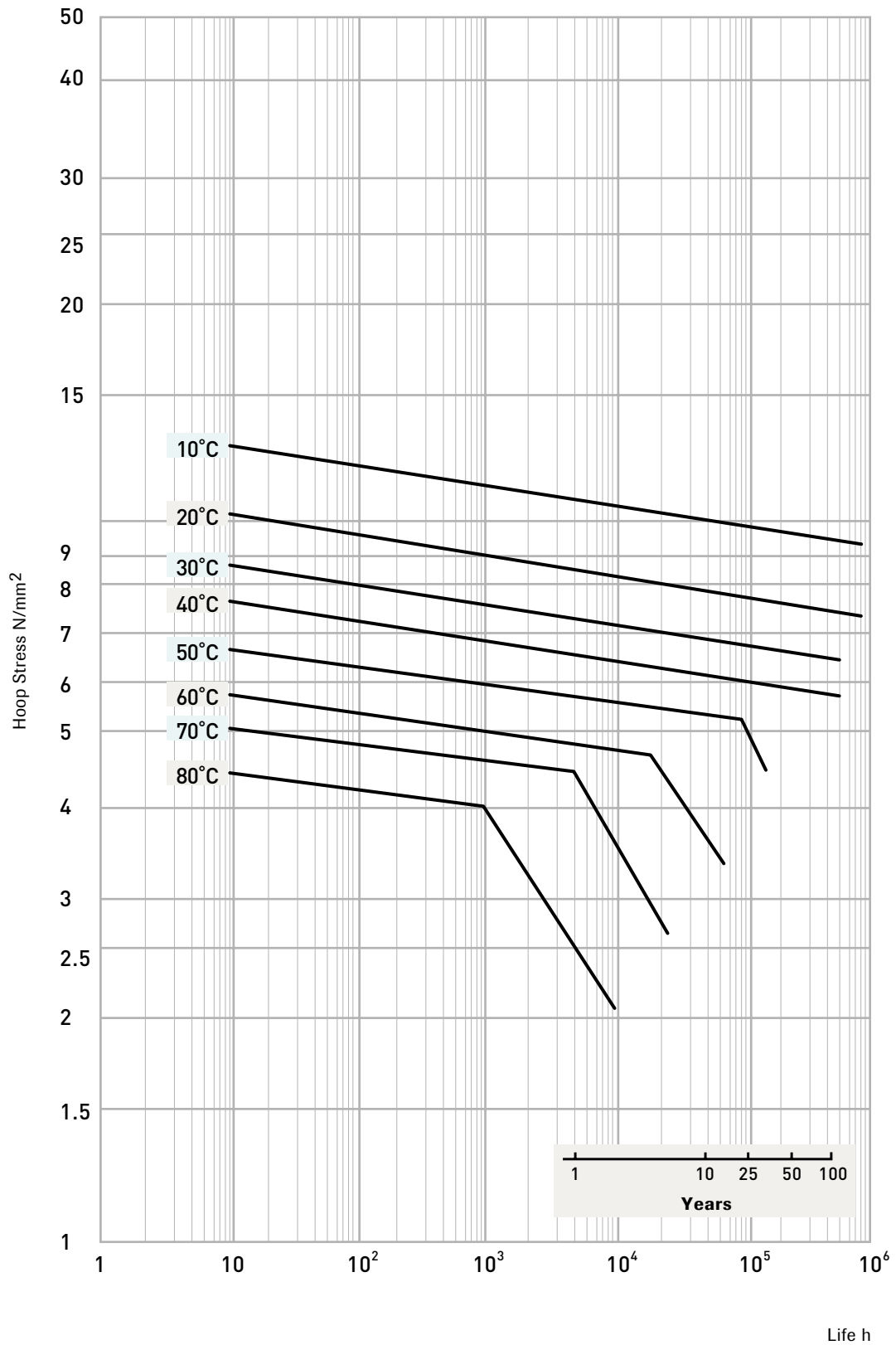

PE 63 Pipes

PE 63 Pipes Pressure-Temperature-Lifespan Table

TEMPERATURE (°C)	OPERATING PERIOD (YEAR)	SDR								
		41	33	26	17.6	13.6	11	9	7.4	6
		PIPE SERIES S								
		20	16	12.5	8.3	6.3	5	4	3.2	2.5
OPERATING PRESSURE (BAR)										
10	5	3.10	4.00	5.00	7.60	10.1	12.7	15.8	20.3	25.4
	10	3.10	3.90	4.90	7.40	9.90	12.4	15.5	19.9	24.9
	25	3.00	3.80	4.80	7.20	9.70	12.1	15.1	19.4	24.2
	50	2.90	3.80	4.70	7.10	9.50	11.9	14.8	19.0	23.8
	100	2.90	3.70	4.60	7.00	9.30	11.6	14.5	18.6	23.3
10	5	2.60	3.40	4.20	6.40	8.50	10.6	13.3	17.0	21.3
	10	2.60	3.30	4.10	6.20	8.30	10.4	13.0	16.7	20.9
	25	2.50	3.20	4.00	6.10	8.10	10.1	12.7	16.3	20.3
	50	2.50	3.20	4.00	6.00	8.00	10.0	12.4	15.9	19.9
	100	2.40	3.10	3.90	5.80	7.80	9.80	12.2	15.6	19.6
30	5	2.20	2.90	3.60	5.40	7.20	9.00	11.3	14.5	18.1
	10	2.20	2.80	3.50	5.30	7.10	8.80	11.1	14.2	17.7
	25	2.10	2.70	3.40	5.20	6.90	8.60	10.8	13.8	17.3
	50	2.10	2.70	3.30	5.00	6.70	8.40	10.6	13.5	16.9
40	5	1.90	2.40	3.10	4.60	6.20	7.70	9.70	12.4	15.5
	10	1.90	2.40	3.00	4.50	6.10	7.60	9.50	12.2	15.2
	25	1.80	2.30	2.90	4.40	5.90	7.40	9.30	11.9	14.8
	50	1.80	2.30	2.90	4.30	5.80	7.20	9.10	11.6	14.5
50	5	1.60	2.10	2.70	4.00	5.40	6.70	8.40	10.9	13.5
	10	1.60	2.00	2.50	3.80	5.10	6.40	8.10	10.3	12.9
	15	1.40	1.80	2.20	3.40	4.50	5.60	7.10	9.10	11.3
60	5	1.10	1.40	1.70	2.60	3.50	4.40	5.50	7.10	8.80
70	2	0.80	1.00	1.30	2.00	2.70	3.30	4.20	5.40	6.70

Pressure Reduction Coefficients Dependent to Temperature

PE pipe system is designed for 20° C. Maximum operating temperature is 40°C. However, in the case of operation in excess of 20°C, coefficients on the right hand side can be used for pipe selection.

Interpolation can be performed for intermediate temperatures. Admissible operating pressure (PFA) is calculated using the following equation.

$$PFA = fT \times fA \times PN$$

Temperature (°C) Coefficient (f_T)

20	1,00
30	0,87
40	0,74

- fT** : Pressure Reduction Coefficient
- fA** : Dependent on Application (Conveying water fA=1), Reduction factor (or Increment factor)
- PN**: Nominal Pressure

PE 63 Borular

PE 63 Pipes Lifespan Table Dependent to Temperature

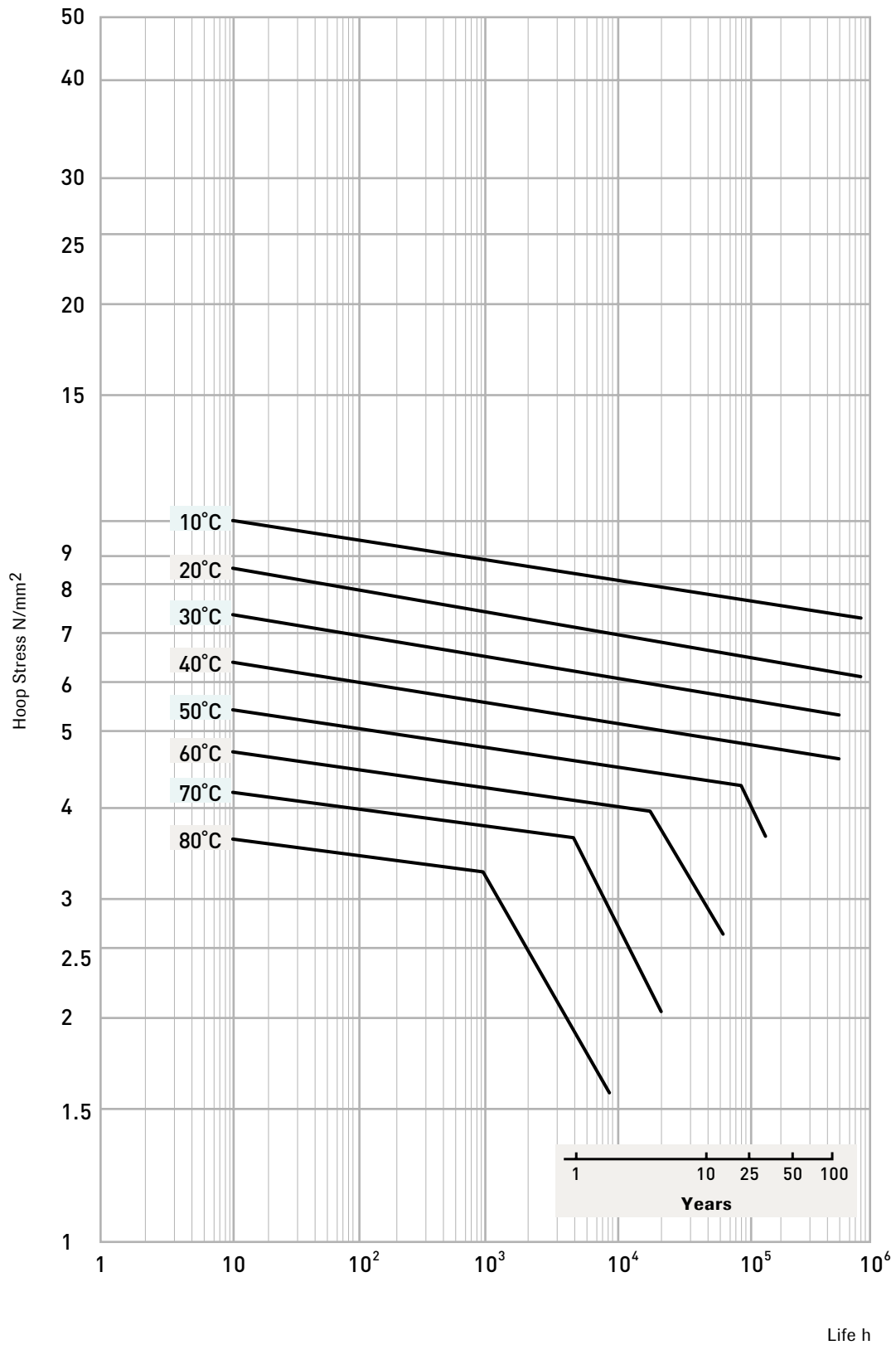

PE Pipes and Fittings

Calculation Basis

Calculation of Wall Thickness

Calculation of wall thickness required for PE pipe nominal pressure is performed using the pipe calculation formula in ISO 161-1.

$$\sigma_s = PN \cdot \frac{da - s_{\min}}{20 \cdot s_{\min}} = PN \cdot S$$

- PN** : Nominal pressure (bar), 1 bar = 0,1 N/mm²
- s** : Wall thickness (mm)
- S** : Pipe series S=da/2.s (-)
- σ_s** : Hoop stress (N/mm²)
- SDR** : Standard dimension ratio SDR= da/s= 2S+1
- da** : Pipe outer diameter (mm)

According to this, minimum wall thickness is as follows.

$$s_{\min} = \frac{PN \cdot da}{20 \cdot \sigma_s + PN}$$

It is dependent to hoop stress safety coefficient and safety coefficient shall be taken into account for calculation.

$$\sigma_s = \frac{MRS}{C}$$

MRS: Minimum Required Strength

Safety coefficient, safety factor is expressed as total operation coefficient in ISO 12162 and has numerous functions. Primarily, safety shall be ensured in case of accuracy of pipe calculations (measurements) and increase of nominal pressure inside the pipe.

For water pipe C_{min} = 1.25

For gas pipe C_{min} = 2.0

Hoop Stress Table for HDPE

Hoop Stress Table for HDPE				Sample Pipe	Ø 110 PN10
PE Class	MRS (N/mm ²)	Stress σ _s (N/mm ²)	Safety Faktor C	Wall Thickness s (mm)	Weigth (kg/m)
PE 63	6.30	5.00	1.25	10.0	3.14
PE 80	8.00	6.30	1.25	8.10	2.62
PE 100	10.0	8.00	1.25	6.60	2.17

PE Pipes and Fittings

Calculation Basis

Stability (Collapse) Pressure

Pipes that are laid under the ground are exposed to loads other than earth load. Those are, as it is the case in sea discharge when pipes are laid straight into the sea, extra loads such as loads that ground water creates, although the pipes are laid under the ground.

Apart from these, stability (collapse) calculation must be done in projects that have overstress such as sleeve concrete made for filling the gap in pipes that engage by sleeve method or additional loads in vacuum pipes that have absorption function.

Stability pressure calculation for PE 100 Pipes:

$$P_k = \frac{10 \cdot E_c}{4 \cdot (1 - \mu^2)} \cdot \left[\frac{s}{r_m} \right]^3$$

- P_k : Critical collapse pressure (bar)
- E_c : Elasticity module (N/mm²)
- μ : Number of transverse thermoplasts 0.4 (-)
- s : Wall thickness (mm)
- r_m : Average pipe radius (mm)

Stability pressure calculation for PE 100 Pipes:

$$\sigma_k = P_k \cdot \frac{r_m}{s}$$

- σ_k : Critical collapse pressure (N/mm²)
- P_k : Critical collapse pressure (bar)
- r_m : Average pipe radius (mm)
- s : Wall thickness (mm)

Hydraulic Calculation of Pipe Diameter

The determination of the pipe section; continuity balance is established if passage flow rate at the fluid passageway is constant.

$$Q = 0.0036 \cdot A \cdot v$$

- Q** : Conveying quantity, flow rate (m³/h)
- A** : Pipe section (mm²)
- v** : Flow rate (m/s)

If the passage flow rate at the gas and steam is constant, continuity balance is established. Below formula is used here:

$$m = 0.0036 \cdot A \cdot v \cdot \rho$$

- m** : Passing flow rate (kg/h)
- ρ** : Density of the conveyed material (kg/m³)

Practical useful formula for calculation of required pipe cross-section is as follows (In this formula, constant numbers are obtained upon multiplication of constant numbers from the above formula):

$$di = 18.8 \cdot \sqrt{\frac{Q^*}{v}} \qquad di = 35.7 \cdot \sqrt{\frac{Q^{**}}{v}}$$

- di** : Pipe internal diameter (mm)
- Q*** : Carriage amount (mm²)
- Q**** : Carriage amount (m/s)

PE Pipes and Fittings

Calculation Basis

Pressure Losses

Values specified below affect hydraulic pressure losses at a high rate:

- Length of the pipeline • Pipe diameter of the flat line
- Smoothness of pipe • Pipe connections (fittings and fixtures)
- Fluid density • Form of flow (regular or irregular flow)

Total pressure losses are the sum of the separate pressure losses as specified below:

$$\Delta p = \sum \Delta p_i = \Delta p_R + \Delta p_F + \Delta p_A + \Delta p_V$$

Calculation of Separate Pressure Losses

In order to calculate the high energy loss (hv) or pressure loss (p) due to passage amount, flow rate and pressure decrease in HDPE pipes, the formulas below are used.

a) Darcy - Weisbach Formula

$$\Delta p = \lambda \cdot \frac{l \cdot v^2 \cdot \rho \cdot 10^{-5}}{2 \cdot d_i} \quad h^\Delta = \lambda \cdot \frac{l \cdot v^2}{2 \cdot g \cdot d_i}$$

m : Pipe internal diameter	(mm)
l : Length of the pipeline	(mm)
v : Average fluid flow rate	(m/s)
ρ : Fluid density	(kg/m ³)
λ : Friction coefficient (0.015 sufficient)	(-)
g : Gravity	(9.81 m/s ²)

High energy loss stands for the elevation differences intended for the desired flow rate in the line. Friction coefficient is within scope of the following general formulas.

b) Colebrook - White Formula

$$\frac{1}{\sqrt{\lambda}} = -2 \log \left(\frac{2.51}{Re \sqrt{\lambda}} + \frac{k_b}{3.71 \cdot d_i} \right)$$

Re : Reynold number	= v·d/v
v : Kinematical fluidity of water	= 1,31 m ² /s
k : Roughness value of internal surface of thr pipe	= 0,015

When the previous formula is transformed:

$$V = \left(-2 \log \left[\frac{2.51 \cdot v}{d_i \sqrt{2 \cdot g \cdot J_e \cdot d}} + \frac{k_b}{3.71 \cdot d} \right] \right) \cdot \sqrt{2 \cdot g \cdot J_e \cdot d}$$

There are two types of smoothness value as wall smoothness "kb" and operating roughness (system roughness) "kb".

v : Flow rate	(m/s)
Je : Energy line centralization tendency	(-)
Kb : Operating roughness	(mm)
g : Gravitational acceleration	(Nm/s ²)
v : Kinematical hardness	(m ² /s)
(1.31x10 ⁶ for waste water under 12°C)	
d : Pipe internal diameter	(mm)

Roughness Values for Various Pipe Lines

Line Type	Roughness k (mm)	
Steel, new	0.01	0.1
Ductile pipe, new	0.0001	1
Ductile pipe, old	0.03	0.2
Plastic pipe (general)	0.01	0.1
HDPE	0.007	0.1
Concrete pipe, new	1.0	2.0
Ceramic pipe	0.1	1.0
Old pipe, operated with aggressive fluids	2.0	

Values which determine Kb Operating roughness:

- Wall roughness
- Flatness of the pipeline (is there ground slope?)
- Water hammer
- Additional entrance lines
- Manholes
- Input and output stores

Roughness values recommended by ATV A 110 standard

Operating Types	Recommended Kb for HDPE	Kb specified in ATV A 110 Standards
Reductional lines, pressurized and non-manholed relining replacement	0.10 mm	0.25 mm
Manhole connected subordinate lines according to ATV A 241 1.1.5	0.25 mm	0.50 mm
Manhole connected collector lines according to ATV A 241 1.1.5	0.50 mm	0.75 mm
Collection canals with additional entrance lines, special manholes with angled tendencies	0.75 mm	1.50 mm

Pressure losses in fittings Δp_F :

$$\Delta p_F = \zeta \cdot \frac{\rho}{2 \cdot 10^2} \cdot v^2 \cdot n$$

- ζ : Fitting resistance value (-)
- ρ : Fluid density (kg/m³)
- Kb** : Flow speed (m/s)
- g** : Number of fittings (-)

Pressure losses in fittings Δp_A :

$$\Delta p_A = \zeta \cdot \frac{\rho}{2 \cdot 10^2} \cdot v^2 \cdot n$$

Resistance value (z) of armatures are between 0.5 and 5.0.
 Armature manufacturer states the exact value.

PE Pipes and Fittings

Calculation Basis

Fittings Pressure Loss Table

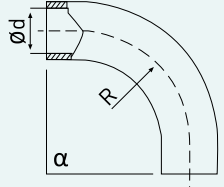
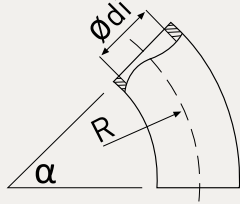
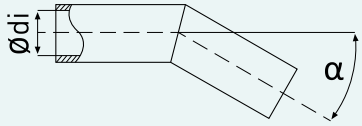
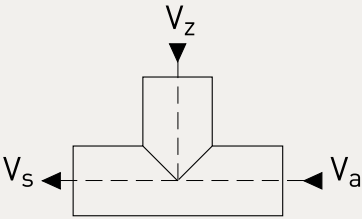
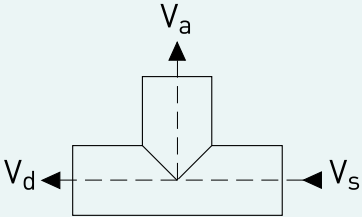
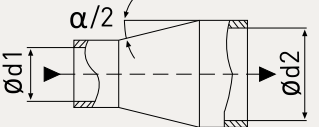
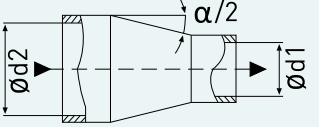
FITTING TYPE	PROPERTY	PRESSURE LOSS COEFFICIENT		FLOW DIRECTION
90° ELBOW	R=1.0xd	0.51		
	1.5xd	0.41		
	2.0xd	0.34		
	4.0xd	0.23		
45° ELBOW	R = 1.0xd	0.34		
	1.5xd	0.27		
	2.0xd	0.20		
	4.0xd	0.15		
ELBOW	a = 45°	0.30		
	30°	0.14		
	20°	0.05		
	15°	0.05		
	20°	0.04		
		V_z / V_s	ζ_z	ζ_c
TEE PART (COLLECTION BRANCH 90°) $V_s = V_a + V_d$	0.0	-1.2	0.06	
	0.2	0.40	0.20	
	0.3	0.10	0.30	
	0.6	0.50	0.40	
	0.8	0.70	0.50	
1.0	0.90	1.60		
		V_a / V_s	ζ_a	ζ_s
TEE PART (DISTRIBUTION BRANCH 90°) $V_s = V_a + V_d$	0.0	0.97	0.10	
	0.2	0.90	0.10	
	0.4	0.10	0.05	
	0.6	0.90	0.10	
	0.8	1.10	0.20	
	1.0	1.30	0.35	
		a	ζ_s	
REDUCER (EXPANDING OUTPUT) $\zeta = \text{value}$ $\lambda_R = 0.025$	30°	0.60		
	45°	0.80		
	60°	1.00		
REDUCER (TAPERING OUTPUT) $\zeta = \text{value}$ $\lambda_R = 0.025$	30°	0.02		
	45°	0.02		
	60°	1.07		

Pressure losses in pipe connections Δp_v :

It is not possible to state an ultimate loss value since there are various types of pipe joining methods (welded, flanged etc.). However, it is required to add an additional rate of 3-5% pressure loss for safety.

c) Hazen - Williams Formula

$$V = 0.85 \cdot C \cdot R^{0.63} \cdot J^{0.54}$$

- V : Speed (meter/second)
- C : Roughness Coefficient
- d : Internal Diameter (meter)
- L : Pipe Length (meter)
- hf : Hydraulic Loss (meter)
- J : Hydraulic Slope

Roughness coefficient "C" is 150 for plastic pipes.

$$h_f = \left[\frac{1.170}{C} \right]^{1.852} \cdot \frac{L}{d^{1.167}} \cdot V^{1.852}$$

$$J = \left[\frac{3.59}{C} \right]^{1.852} \cdot \left[\frac{Q}{d^{4.87}} \right]^{1.852}$$

d) Manning Formula

$$Q = A \cdot V$$

$$V = \frac{1}{n} \cdot R^{2/3} \cdot J^{1/2}$$

$$Q = \frac{\pi}{4} \cdot D^2 \cdot \frac{1}{K} \cdot R^{2/3} \cdot J^{1/2}$$

- Q : Flow Rate (m²/second)
- V : Speed (meter/second)
- K : Roughness Coefficient
- R : Hydraulic Radius (m)
- J : Hydraulic Slope

Roughness coefficient "K" is 0.009 for PE pipes.

PE Pipes and Fittings

Calculation Basis

PE 100, PN10 Pipes Pressure Losses Table according to Colebrook-White Formula $k=0.015$ mm

D = 75 mm s = 4.5 mm Di = 66 mm			D = 90 mm s = 5.4 mm Di = 79.2 mm			D = 110 mm s = 6.6 mm Di = 96.8 mm			D = 125 mm s = 7.4 mm Di = 110.2 mm		
Speed m/sn	Flow Rate l/sn	J m/1000m	Speed m/sn	Flow Rate l/sn	J m/1000m	Speed m/sn	Flow Rate l/sn	J m/1000m	Speed m/sn	Flow Rate l/sn	J m/1000m
0.20	0.68	0.92	0.20	0.98	0.73	0.20	1.47	0.58	0.20	1.91	0.47
0.30	1.03	1.75	0.30	1.48	1.50	0.30	2.21	1.13	0.30	2.86	0.93
0.40	1.37	3.19	0.40	1.97	2.51	0.40	2.94	1.97	0.40	3.81	1.61
0.50	1.71	4.51	0.50	2.46	3.47	0.50	3.68	2.87	0.50	4.77	2.45
0.60	2.05	6.03	0.60	2.95	4.87	0.60	4.41	3.92	0.60	5.72	3.34
0.70	2.39	8.37	0.70	3.45	6.49	0.70	5.15	5.30	0.70	6.67	4.35
0.80	2.74	10.35	0.80	3.94	8.32	0.80	5.88	6.66	0.80	7.63	5.62
0.90	3.08	13.28	0.90	4.43	10.35	0.90	6.62	8.39	0.90	8.58	7.04
1.00	3.42	15.71	1.00	4.92	12.80	1.00	7.36	10.05	1.00	9.53	8.44
1.10	3.76	18.32	1.10	5.42	15.02	1.10	8.09	11.85	1.10	10.49	10.13
1.20	4.10	22.08	1.20	5.91	17.65	1.20	8.83	14.08	1.20	11.44	11.77
1.30	4.45	25.12	1.30	6.40	20.48	1.30	9.56	16.17	1.30	12.39	13.53
1.40	4.79	29.46	1.40	6.89	23.51	1.40	10.30	18.73	1.40	13.35	15.62
1.50	5.13	32.92	1.50	7.39	26.07	1.50	11.03	21.11	1.50	14.30	17.62
1.60	5.47	36.56	1.60	7.88	29.45	1.60	11.77	23.62	1.60	15.25	19.97
1.70	5.81	41.69	1.70	8.37	33.02	1.70	12.50	26.62	1.70	16.21	22.20
1.80	6.16	45.75	1.80	8.86	36.78	1.80	13.24	29.46	1.80	17.16	24.82
1.90	6.50	51.44	1.90	9.36	40.73	1.90	13.98	32.82	1.90	18.11	27.29
2.00	6.84	55.91	2.00	9.85	44.87	2.00	14.71	35.91	2.00	19.07	30.17
2.10	7.18	60.56	2.10	10.34	49.20	2.10	15.45	39.12	2.10	20.02	32.87
2.20	7.52	67.03	2.20	10.83	53.00	2.20	16.18	42.95	2.20	20.97	36.00
2.30	7.86	72.09	2.30	11.33	58.02	2.30	16.92	46.44	2.30	21.93	38.94
2.40	8.21	79.10	2.40	11.82	58.43	2.40	17.65	50.59	2.40	22.88	42.33
2.50	8.55	84.56	2.50	12.31	63.32	2.50	18.39	54.36	2.50	23.83	45.85
2.60	8.89	90.20	2.60	12.80	67.37	2.60	19.12	58.25	2.60	24.79	49.14
2.70	9.23	97.98	2.70	13.29	72.60	2.70	19.86	62.86	2.70	25.74	52.92
2.80	9.57	104.03	2.80	13.79	78.02	2.80	20.60	67.04	2.80	26.69	56.44
2.90	9.92	112.36	2.90	14.28	83.63	2.90	21.33	71.96	2.90	27.65	60.06
3.00	10.26	118.78	3.00	14.77	89.42	3.00	22.07	76.41	3.00	28.60	64.21

PE 100, PN10 Pipes Pressure Losses Table according to Colebrook-White Formula $k=0.015$ mm

D = 140 mm s = 8.3 mm Di = 66 mm			D = 160 mm s = 9.5 mm Di = 141 mm			D = 180 mm s = 10.7 mm Di = 158.6 mm			D = 200 mm s = 11.9 mm Di = 176.2 mm		
Speed m/sn	Flow Rate l/sn	J m/1000m	Speed m/sn	Flow Rate l/sn	J m/1000m	Speed m/sn	Flow Rate l/sn	J m/1000m	Speed m/sn	Flow Rate l/sn	J m/1000m
0.20	2.39	0.41	0.20	3.12	0.34	0.20	3.95	0.31	0.20	4.87	0.27
0.30	3.59	0.85	0.30	4.68	0.72	0.30	5.92	0.62	0.30	7.31	0.54
0.40	4.78	1.42	0.40	6.24	1.18	0.40	7.90	1.04	0.40	9.75	0.92
0.50	5.98	2.12	0.50	7.80	1.79	0.50	9.87	1.56	0.50	12.19	1.37
0.60	7.17	2.95	0.60	9.36	2.51	0.60	11.85	2.17	0.60	14.62	1.89
0.70	8.37	3.90	0.70	10.92	3.28	0.70	13.82	2.88	0.70	17.06	2.52
0.80	9.56	4.96	0.80	12.49	4.20	0.80	15.80	3.64	0.80	19.50	3.20
0.90	10.76	6.15	0.90	14.05	5.16	0.90	17.77	4.52	0.90	21.93	3.99
1.00	11.95	7.45	1.00	15.61	6.29	1.00	19.75	5.49	1.00	24.37	4.82
1.10	13.15	8.87	1.10	17.17	7.52	1.10	21.72	6.55	1.10	26.81	5.73
1.20	14.34	10.40	1.20	18.73	8.77	1.20	23.70	7.69	1.20	29.25	6.71
1.30	15.54	12.05	1.30	20.29	10.19	1.30	25.67	8.86	1.30	31.68	7.80
1.40	16.74	13.81	1.40	21.85	11.62	1.40	27.64	10.17	1.40	34.12	8.97
1.50	17.93	15.68	1.50	23.41	13.24	1.50	29.62	11.56	1.50	36.56	10.16
1.60	19.13	17.66	1.60	24.97	14.96	1.60	31.59	13.04	1.60	38.99	11.42
1.70	20.32	19.75	1.70	26.53	16.66	1.70	33.57	14.60	1.70	41.43	12.82
1.80	21.52	21.95	1.80	28.09	18.57	1.80	35.54	16.16	1.80	43.87	14.22
1.90	22.71	24.26	1.90	29.65	20.45	1.90	34.52	17.89	1.90	46.31	15.76
2.00	23.91	26.68	2.00	31.21	22.55	2.00	39.49	19.69	2.00	48.74	17.31
2.10	25.10	29.21	2.10	32.77	24.74	2.10	41.47	21.58	2.10	51.18	18.93
2.20	26.30	31.85	2.20	34.33	26.89	2.20	43.44	23.55	2.20	53.62	20.68
2.30	27.49	34.59	2.30	35.90	29.27	2.30	45.42	25.50	2.30	56.05	22.44
2.40	28.69	37.45	2.40	37.46	31.59	2.40	47.39	27.63	2.40	58.49	24.34
2.50	29.88	40.41	2.50	39.02	34.16	2.50	49.36	29.84	2.50	60.93	26.23
2.60	31.08	43.48	2.60	40.58	26.82	2.60	51.34	32.13	2.60	63.37	28.20
2.70	32.27	46.66	2.70	42.14	39.40	2.70	53.31	34.51	2.70	65.80	30.31
2.80	33.47	49.94	2.80	43.70	42.25	2.80	55.29	36.84	2.80	68.24	32.41
2.90	34.67	53.33	2.90	45.26	45.01	2.90	57.26	39.37	2.90	70.68	34.67
3.00	35.86	56.83	3.00	46.82	48.04	3.00	59.24	41.98	3.00	73.11	36.91

PE Pipes and Fittings

Calculation Basis

PE 100, PN10 Pipes Pressure Losses Table according to Colebrook-White Formula $k=0.015$ mm

D = 225 mm s = 13.4 mm Di = 198.2 mm			D = 250 mm s = 14.8 mm Di = 220.4 mm			D = 280 mm s = 16.6 mm Di = 246.8 mm			D = 315 mm s = 18.7 mm Di = 277.6 mm		
Speed m/sn	Flow Rate l/sn	J m/1000m	Speed m/sn	Flow Rate l/sn	J m/1000m	Speed m/sn	Flow Rate l/sn	J m/1000m	Speed m/sn	Flow Rate l/sn	J m/1000m
0.20	6.17	0.23	0.20	7.63	0.20	0.20	9.56	0.18	0.20	12.10	0.15
0.30	9.25	0.48	0.30	11.44	0.42	0.30	14.34	0.36	0.30	18.15	0.31
0.40	12.33	0.80	0.40	15.25	0.70	0.40	19.13	0.60	0.40	24.20	0.53
0.50	15.42	1.19	0.50	19.07	1.04	0.50	23.91	0.91	0.50	30.25	0.78
0.60	18.50	1.65	0.60	22.88	1.45	0.60	28.69	1.26	0.60	36.30	1.10
0.70	21.59	2.17	0.70	26.69	1.92	0.70	33.47	1.67	0.70	42.35	1.45
0.80	24.67	2.78	0.80	30.51	2.46	0.80	38.25	2.13	0.80	48.39	1.85
0.90	27.75	3.45	0.90	34.32	3.04	0.90	43.03	2.64	0.90	54.44	2.30
1.00	30.84	4.19	1.00	38.13	3.69	1.00	47.81	3.20	1.00	60.49	2.79
1.10	33.92	4.99	1.10	41.95	4.39	1.10	52.60	3.82	1.10	66.54	3.32
1.20	37.00	5.86	1.20	45.76	5.15	1.20	57.38	4.49	1.20	72.59	3.90
1.30	40.09	6.80	1.30	49.57	5.98	1.30	62.16	5.19	1.30	78.64	4.52
1.40	43.17	7.79	1.40	53.39	6.85	1.40	66.94	5.95	1.40	84.69	5.18
1.50	46.26	8.85	1.50	57.20	7.78	1.50	71.72	6.77	1.50	90.74	5.89
1.60	49.34	9.94	1.60	61.01	8.76	1.60	76.50	7.63	1.60	96.79	6.63
1.70	52.42	11.13	1.70	64.82	9.80	1.70	81.28	8.54	1.70	102.84	7.42
1.80	55.51	12.38	1.80	68.64	10.92	1.80	86.07	9.48	1.80	108.89	8.26
1.90	58.59	13.69	1.90	72.45	12.06	1.90	90.85	10.49	1.90	114.94	9.12
2.00	61.67	15.06	2.00	76.26	13.26	2.00	95.63	11.54	2.00	120.99	10.04
2.10	64.76	16.50	2.10	80.08	14.52	2.10	100.41	12.65	2.10	127.04	10.99
2.20	67.84	18.00	2.20	83.89	15.82	2.20	105.19	13.80	2.20	133.09	12.00
2.30	70.93	19.56	2.30	87.70	17.22	2.30	109.97	14.97	2.30	139.14	13.03
2.40	74.01	21.18	2.40	91.52	18.64	2.40	114.75	16.22	2.40	145.18	14.11
2.50	77.09	22.81	2.50	95.33	20.11	2.50	119.54	17.51	2.50	151.23	15.23
2.60	80.18	24.55	2.60	99.14	21.63	2.60	124.32	18.05	2.60	157.28	16.40
2.70	83.26	26.35	2.70	102.96	23.21	2.70	129.10	20.23	2.70	163.33	17.59
2.80	86.34	28.22	2.80	106.77	24.88	2.80	133.88	21.64	2.80	169.38	18.84
2.90	89.43	30.14	2.90	110.58	26.56	2.90	138.66	23.12	2.90	175.43	20.11
3.00	92.51	32.13	3.00	114.40	28.30	3.00	143.44	24.64	3.00	181.48	21.45

PE 100, PN10 Pipes Pressure Losses Table according to Colebrook-White Formula $k=0.015$ mm

D = 355 mm s = 21.1 mm Di = 312.8 mm			D = 400 mm s = 23.7 mm Di = 352.6 mm			D = 450 mm s = 26.7 mm Di = 396.6 mm			D = 500 mm s = 29.7 mm Di = 440.6 mm		
Speed m/sn	Flow Rate l/sn	J m/1000m	Speed m/sn	Flow Rate l/sn	J m/1000m	Speed m/sn	Flow Rate l/sn	J m/1000m	Speed m/sn	Flow Rate l/sn	J m/1000m
0.20	15.36	0.13	0.20	19.52	0.11	0.20	24.69	0.10	0.20	30.48	0.09
0.30	23.04	0.27	0.30	29.28	0.23	0.30	37.04	0.20	0.30	45.72	0.18
0.40	30.72	0.45	0.40	39.04	0.39	0.40	49.39	0.34	0.40	60.96	0.30
0.50	38.40	0.68	0.50	48.80	0.59	0.50	61.74	0.51	0.50	76.20	0.45
0.60	46.08	0.95	0.60	58.56	0.83	0.60	74.08	0.71	0.60	91.43	0.63
0.70	53.77	1.26	0.70	68.32	1.09	0.70	86.43	0.95	0.70	106.67	0.84
0.80	61.45	1.60	0.80	78.08	1.39	0.80	98.78	1.21	0.80	121.91	1.07
0.90	69.13	1.99	0.90	87.84	1.72	0.90	111.13	1.50	0.90	137.15	1.32
1.00	76.81	2.42	1.00	97.60	2.10	1.00	123.47	1.82	1.00	152.39	1.61
1.10	84.49	2.88	1.10	107.36	2.50	1.10	135.82	2.17	1.10	167.63	1.92
1.20	92.17	3.38	1.20	117.12	2.93	1.20	148.17	2.55	1.20	182.87	2.25
1.30	99.85	3.91	1.30	126.88	3.40	1.30	160.52	2.96	1.30	198.11	2.61
1.40	107.53	4.49	1.40	136.64	3.90	1.40	172.86	3.29	1.40	216.35	3.00
1.50	115.21	5.11	1.50	146.39	4.43	1.50	185.21	3.85	1.50	228.59	3.41
1.60	122.89	5.76	1.60	156.15	4.99	1.60	197.56	4.34	1.60	243.83	3.84
1.70	130.57	6.44	1.70	165.91	5.59	1.70	209.91	4.86	1.70	259.06	4.29
1.80	138.25	7.16	1.80	175.67	6.21	1.80	222.25	5.41	1.80	274.30	4.78
1.90	145.93	7.92	1.90	185.43	6.87	1.90	234.60	5.98	1.90	289.54	5.29
2.00	153.61	8.71	2.00	195.19	7.56	2.00	246.95	6.58	2.00	304.78	5.81
2.10	161.30	9.54	2.10	204.95	8.28	2.10	259.30	7.21	2.10	320.02	6.37
2.20	168.98	10.41	2.20	214.71	9.03	2.20	271.64	7.86	2.20	335.26	6.95
2.30	176.66	11.30	2.30	224.47	9.82	2.30	283.99	8.54	2.30	350.50	7.55
2.40	184.34	12.24	2.40	234.23	10.62	2.40	296.34	9.25	2.40	365.74	8.18
2.50	192.02	13.22	2.50	243.99	11.47	2.50	308.68	9.99	2.50	380.98	8.83
2.60	199.70	14.23	2.60	253.75	12.35	2.60	321.03	10.75	2.60	396.22	9.50
2.70	207.38	15.28	2.70	263.51	13.25	2.70	333.38	11.54	2.70	411.46	10.20
2.80	215.06	16.34	2.80	273.27	14.19	2.80	345.73	12.35	2.80	426.69	10.92
2.90	222.74	17.46	2.90	283.03	15.15	2.90	358.07	13.19	2.90	441.93	11.66
3.00	230.42	18.61	3.00	292.79	16.16	3.00	370.42	14.06	3.00	457.17	12.44

PE Pipes and Fittings

Calculation Basis

PE 100, PN10 Pipes Pressure Losses Table according to Colebrook-White Formula $k=0.015$ mm

D = 500 mm s = 33.2 mm Di = 493.6 mm			D = 630 mm s = 37.4 mm Di = 555.3 mm			D = 710 mm s = 42.1 mm Di = 625.8 mm			D = 800 mm s = 47.4 mm Di = 705.2 mm		
Speed m/sn	Flow Rate l/sn	J m/1000m	Speed m/sn	Flow Rate l/sn	J m/1000m	Speed m/sn	Flow Rate l/sn	J m/1000m	Speed m/sn	Flow Rate l/sn	J m/1000m
0.20	38.25	0.08	0.20	48.39	0.07	0.20	61.49	0.06	0.20	78.08	-----
0.30	57.38	0.16	0.30	72.59	0.14	0.30	92.23	0.12	0.30	117.12	0.10
0.40	76.50	0.26	0.40	96.79	0.23	0.40	122.97	0.20	0.40	156.15	0.17
0.50	95.63	0.39	0.50	120.99	0.34	0.50	153.71	0.30	0.50	195.19	0.26
0.60	114.75	0.55	0.60	145.18	0.48	0.60	184.46	0.42	0.60	234.23	0.36
0.70	133.88	0.73	0.70	169.38	0.63	0.70	215.20	0.55	0.70	273.27	0.48
0.80	153.01	0.93	0.80	193.58	0.81	0.80	245.94	0.70	0.80	312.31	0.61
0.90	172.13	1.16	0.90	217.78	1.01	0.90	276.68	0.87	0.90	351.35	0.76
1.00	191.26	1.41	1.00	241.97	1.22	1.00	307.43	1.06	1.00	390.39	0.92
1.10	210.38	1.68	1.10	266.17	1.46	1.10	338.17	1.27	1.10	429.42	1.10
1.20	229.51	1.97	1.20	290.37	1.71	1.20	368.91	1.49	1.20	468.46	1.29
1.30	248.64	2.28	1.30	314.57	1.99	1.30	399.65	1.72	1.30	408.50	1.50
1.40	267.76	2.62	1.40	338.76	2.28	1.40	430.40	1.98	1.40	546.54	1.72
1.50	286.89	2.98	1.50	362.96	2.59	1.50	461.14	2.25	1.50	585.58	1.95
1.60	306.01	3.35	1.60	387.16	2.92	1.60	491.88	2.54	1.60	624.62	2.20
1.70	325.14	3.76	1.70	411.36	3.27	1.70	522.62	2.84	1.70	663.66	2.47
1.80	344.26	4.18	1.80	435.55	3.64	1.80	553.37	3.16	1.80	702.69	2.74
1.90	363.39	4.62	1.90	459.75	4.02	1.90	584.11	3.49	1.90	741.73	3.03
2.00	382.52	5.09	2.00	483.95	4.43	2.00	614.85	3.84	2.00	780.77	3.34
2.10	401.64	5.57	2.10	508.15	4.85	2.10	645.59	4.21	2.10	819.81	3.66
2.20	420.77	6.08	2.20	532.34	5.29	2.20	676.34	4.59	2.20	858.85	3.99
2.30	439.89	6.60	2.30	556.54	5.75	2.30	707.08	4.99	2.30	897.89	4.34
2.40	459.02	7.15	2.40	580.74	6.22	2.40	737.82	5.41	2.40	936.93	4.70
2.50	478.15	7.72	2.50	604.93	6.72	2.50	768.57	5.85	2.50	975.97	5.07
2.60	497.25	8.31	2.60	629.13	7.24	2.60	799.31	6.29	2.60	1015.00	5.46
2.70	516.40	8.92	2.70	653.33	7.77	2.70	830.05	6.75	2.70	1054.04	5.86
2.80	535.52	9.55	2.80	677.53	8.32	2.80	860.79	7.23	2.80	1093.08	6.28
2.90	554.65	10.21	2.90	701.72	8.88	2.90	891.54	7.72	2.90	1132.12	6.71
3.00	573.77	10.88	3.00	725.92	9.47	3.00	922.28	8.23	3.00	1171.16	7.15

PE 100, PN10 Pipes Pressure Losses Table according to Colebrook-White Formula $k=0.015$ mm

D = 900 mm s = 53.3 mm Di = 793.4 mm			D = 1000 mm s = 593 mm Di = 881.4 mm			D = 1200 mm s = 706 mm Di = 1058.8 mm		
Speed m/sn	Flow Rate l/sn	J m/1000m	Speed m/sn	Flow Rate l/sn	J m/1000m	Speed m/sn	Flow Rate l/sn	J m/1000m
0.40	197.66	0.15	0.40	243.94	0.13	0.40	352.01	0.11
0.50	247.07	0.22	0.50	304.92	0.20	0.50	440.02	0.16
0.60	296.49	0.31	0.60	365.90	0.28	0.60	528.02	0.22
0.70	345.90	0.42	0.70	426.89	0.37	0.70	616.02	0.30
0.80	395.32	0.53	0.80	487.87	0.47	0.80	704.02	0.38
0.90	444.73	0.66	0.90	548.86	0.58	0.90	792.03	0.47
1.00	494.14	0.80	1.00	609.84	0.71	1.00	880.03	0.57
1.10	543.56	0.96	1.10	670.82	0.84	1.10	968.03	0.68
1.20	592.97	1.12	1.20	731.81	0.99	1.20	1056.04	0.80
1.30	642.39	1.30	1.30	792.79	1.15	1.30	1144.04	0.93
1.40	691.80	1.50	1.40	853.78	1.32	1.40	1232.04	1.07
1.50	741.22	1.70	1.50	914.76	1.50	1.50	1320.05	1.21
1.60	790.63	1.92	1.60	975.74	1.69	1.60	1408.05	1.37
1.70	840.05	2.15	1.70	1036.73	1.90	1.70	1496.05	1.53
1.80	889.46	2.39	1.80	1097.71	2.11	1.80	1584.05	1.70
1.90	938.87	2.64	1.90	1158.70	2.34	1.90	1672.06	1.88
2.00	988.29	2.91	2.00	1219.68	2.57	2.00	1760.06	2.07
2.10	1037.70	3.19	2.10	1280.66	2.82	2.10	1848.06	2.27
2.20	1087.12	3.48	2.20	1341.65	3.07	2.20	1936.07	2.48
2.30	1136.53	3.78	2.30	1402.63	3.34	2.30	2024.07	2.70
2.40	1185.95	4.09	2.40	1463.62	3.62	2.40	2112.07	2.92
2.50	1235.36	4.42	2.50	1524.60	3.91	2.50	2200.08	3.15
2.60	1284.78	4.76	2.60	1585.58	4.21	2.60	2288.08	3.40
2.70	1134.19	5.11	2.70	1646.57	4.52	2.70	2376.08	3.65
2.80	1383.60	5.47	2.80	1707.55	4.84	2.80	2464.08	3.90
2.90	1433.02	5.84	2.90	1768.54	5.17	2.90	2552.09	4.17
3.00	1482.43	6.23	3.00	1829.52	5.51	3.00	2640.09	4.45

Water Hammer

Water hammer occurs when valve or pump is turned on/off For this, following formula is used theoretically.

$$p_s = \frac{a \cdot v}{\rho}$$

a : Propagation speed of pressure wave (m/s)
 v : Flow speed of the fluid (m/s)
 ρ : Fluid density (m/s²)

In practice Ps value can be negative or positive:
 Positive : During turning off taps and turning on the pump.
 Negative: Turning off the pump or sudden change of hydraulic property (Example: reduction of flow speed).

Propagation speed of pressure wave is calculated according to the following formula:

$$a = \sqrt{\frac{\frac{E_m}{\rho}}{1 + \frac{E_m}{E_r} \cdot \frac{d_m}{e}}}$$

E_m : Elasticity module of fluid (Esu=2100.10⁶ N/m²)
 ρ : Fluid density (ρsu =1000 kg/m²)
 E_r : Elasticity module of the material (pipe) (N/m²)
 D_m : Pipe intermediate diameter (d_m=d-e) (m)
 e : Pipe wall thickness (m)

Short term elasticity module shall be used in this formula.
 (Er= 800_1200N/mm2).

Short term pressure changes and water hammer effect does not cause damage in HDPE pipes. Following example table indicates the rate of increase of new pressure value which is generated by short term water hammer under 20°C temperature for the various safety factors according to the nominal pressure. Pressure increases occurring within these values do not damage the pipe.

Safety Factor - Water Hammer Relation in PE Pipes

Total Operating Coefficient C (Safety Factor)	Rate of Pressure Increase to Nominal Pressure Under Effect of Short Term Water Hammer
1.25	50 %
1.60	1000 %



Thermal Extension

(Elongation in Length due to Temperature Variation)

Elongation in length due to temperature variation shall be taken into consideration while laying HDPE (PE- 80, PE- 100) pipes. In the case that the temperature is increased elongation will occur in length and contraction will occur in case of decrease in temperature.

At 1 m of PE pipe, for temperature variation for each "K" number (1K=1°C), 0.18 mm elongation or contraction will occur.

$$\Delta L = \alpha \cdot L \cdot \Delta T \quad (\Delta L = m \cdot K \cdot mm/m.K^{-1})$$

For instance, in case of elongation or contraction dependent to temperature, in length in a line built with PE piping, pipe will move from the turning point instead of the fixed point. Assume that for a 12 m pipe normal operating temperature $T_v = 20^\circ C$, maximum operating temperature $T_1 = 65^\circ C$ and minimum operating pressure $T_2 = 10^\circ C$. According to this, variations in length dependent to temperature are calculated as follows.

Elongation dependent to temperature increase:

$$+\Delta L = L \cdot \Delta T_1 \cdot \alpha = 12 \cdot 45 \cdot 0,18 = 97,2 \text{ mm}$$

Contraction dependent to temperature decrease:

$$-\Delta L = L \cdot \Delta T_2 \cdot \alpha = 12 \cdot 10 \cdot 0,18 = 21,60 \text{ mm}$$

$$L_s = k \cdot \sqrt{d \cdot \Delta L}$$

L_s : Fixing distance (mm)
d : Pipe outer diameter (mm)
k : Factor
 26 for HDPE
 30 for PP
 33.5 for PVC

Coefficients of Elongation in Length for Various Plastic Materials

Material	$\alpha \cdot$ Coefficient mm/m.K
HDPE	0.18
PP	0.15
PVDF	0.14
PB	0.12
PVC	0.07
GFK	0.02

If it is $\Delta L = 97.2$ mm for a PE pipe with diameter of $\varnothing 63$ mm, factor is 26 and clamp distance is as follows.

Expansion Points

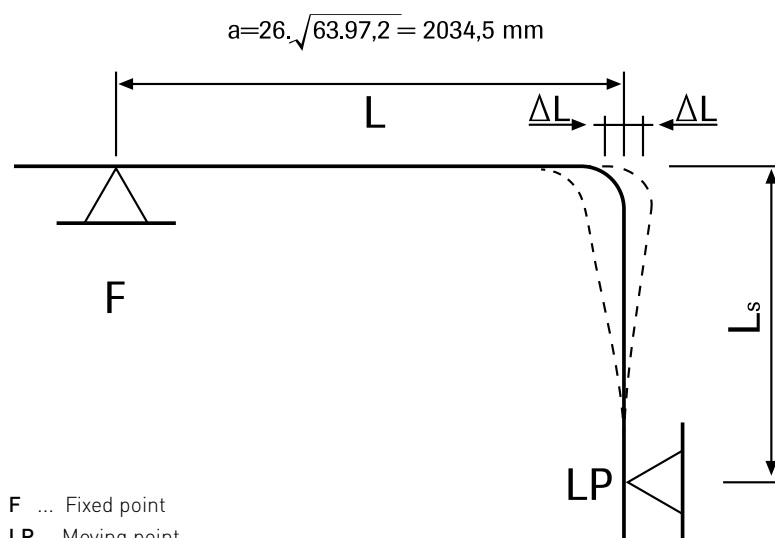

Bending Radius

Maximum bending radius PE pipes:

$$R = \frac{E \cdot D_m}{2 \cdot \sigma}$$

R : Bending radius (mm)
 D_m : Average pipe diameter (mm)
 E : Pipe elasticity module (N/mm²)
 σ : Stress (N/mm²)

Admissible small bending radius shall not drop under the value indicated in the below table.

Hoop Stress of PE Pipes:

HDPE Class	Hoop Stress N/mm ²
PE 63	5
PE 80	6.3
PE 100	8



Bending Radius for PE Pipes:

		Admissible Small Bending Radius	
Pipe Raw material	Installation Temperature	SDR 17	SDR 11
PE 80 ve PE 100	20 °C	30 x da	20 x da
	10 °C	50 x da	35 x da
	0 °C	75 x da	50 x da

da : Pipe outer diameter

Breaking possibility constitutes the critical point in calculation of bending radius for thin walled pipes. In thick walled pipes, stress-warping limit constitutes the critical point while calculating the diameter for bending process, following formula is applied while calculating the admissible radius of bending for thin walled pipes:

$$R_k = \frac{r_m^2}{0.28.s} \text{ [mm]}$$

r_m : Average pipe radius (mm)
 s : Wall thickness (mm)

Following formula is applied while calculating (by considering stress-warping) the admissible radius of bending for thick walled pipes:

$$R = \frac{r_a.100}{\epsilon} \text{ [mm]}$$

r_a : Pipe outer radius (mm)
 ϵ : Stress-Warping (mm)

* Stress-Warping rate shall not exceed 2.5%.

Bending Radius of PE Pipes According to SDR: (20 °C)

Pipe Series	SDR	Admissible Bending Radius R d= Pipe Outer Diameter
20	41	50 d
16	33	40 d
12.5	26	30 d
8	17	30 d
5	11	20 d
3.2	7.4	20 d



For admissible bending radius under operating temperatures lower than 0°C, 2.5 shall be added to the value indicated in the above table.

Admissible bending radius under operating temperatures of 0°-20°C is found by calculating the intermediate value [rate].

PE Pipes

Calculation tables

PE 100 Pipes

ISO 4427-2

TS EN 12201-2 + A1

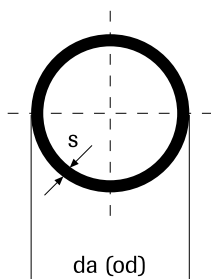

PE 100 Pipe Calculation Table

da mm	SDR 41 - PN 4			SDR 33 - PN 5			SDR 26 - PN 6			SDR 21 - PN 8		
	Code	S mm	Kg/m	Code	S mm	Kg/m	Code	S mm	Kg/m	Code	S mm	Kg/m
20												
25												
32												
40										7.500.184.040	2.00	0.239
50							7.500.180.056	2.00	0,314	7.500.184.050	2.40	0.359
63							7.500.186.463	2.50	0,494	7.500.184.063	3.00	0.565
75							7.500.186.475	2.90	0,675	7.500.184.075	3.60	0.807
90							7.500.186.094	3.50	0,978	7.500.184.090	4.30	1.160
110							7.500.186.114	4.20	1,430	7.500.184.110	5.30	1.740
125							7.500.186.124	4.80	1,840	7.500.184.125	6.00	2.200
140							7.500.186.146	5.40	2,320	7.500.184.140	6.70	2.800
160							7.500.186.162	6.20	3,040	7.500.184.160	7.70	3.680
180							7.500.186.184	6.90	3,790	7.500.184.180	8.60	4.630
200							7.500.186.221	7.70	4,690	7.500.184.200	9.60	5.730
225							7.500.186.227	8.60	5,890	7.500.184.225	10.8	7.260
250							7.500.186.254	9.60	7,300	7.500.184.250	11.9	8.900
280							7.500.186.284	10.7	9,100	7.500.184.280	13.4	11.22
315	7.500.187.315	7.70	7.52	7.500.187.315	9.70	9.370	7.500.186.416	12.1	11,60	7.500.184.315	15.0	14.13
355	7.500.187.355	8.70	9.55	7.500.187.355	10.9	11.80	7.500.186.354	13.6	14,60	7.500.184.355	16.9	17.94
400	7.500.187.400	9.80	12.1	7.500.187.400	12.3	15.10	7.500.186.404	15.3	18,60	7.500.184.400	19.1	22.84
450	7.500.187.450	11.0	15.3	7.500.187.450	13.8	19.00	7.500.186.451	17.2	23,50	7.500.184.450	21.5	28.90
500	7.500.187.500	12.3	19.0	7.500.187.500	15.3	23.40	7.500.186.504	19.1	28,90	7.500.184.500	23.9	35.70
560	7.500.187.560	13.7	23.6	7.500.187.560	17.2	29.40	7.500.186.564	21.4	36,20	7.500.184.560	26.7	44.70
630	7.500.187.630	15.4	29.9	7.500.187.630	19.3	37.10	7.500.186.634	24.1	45,90	7.500.184.630	30.0	56.50
710	7.500.187.710	17.4	38.0	7.500.187.710	21.8	47.20	7.500.186.714	27.2	58,40	7.500.184.710	33.9	72.00
800	7.500.187.800	19.6	48.1	7.500.187.800	24.5	59.70	7.500.186.804	30.6	73,90	7.500.184.800	38.1	91.20
900	7.500.187.900	22.0	60.9	7.500.187.900	27.6	75.60	7.500.186.905	34.4	93,40	7.500.184.900	42.9	115.0
1000	7.500.187.910	24.5	75.2	7.500.187.910	30.6	93.10	7.500.186.100	38.2	115,0	7.500.184.910	47.7	143.0
1200	7.500.187.920	29.4	108.0	7.500.187.920	36.7	134.0	7.500.186.120	45.9	166,0	7.500.184.912	57.2	205.0
1400	7.500.187.940	34.3	147.0	7.500.187.940	42.9	183.0	7.500.186.915	53.5	226,0	7.500.184.915	66.7	279.0
1600	7.500.187.960	39.2	192.0	7.500.187.960	49.0	238.0	7.500.186.918	61.2	295,0	7.500.184.918	76.2	365.0
1800	7.500.187.965	44.0	246.0	7.500.187.965	55.1	306.0	7.500.186.920	68.8	379,0	7.500.184.920	85.8	467.0
2000	7.500.187.970	48.9	303.0	7.500.187.970	61.2	378.0	7.500.186.930	76.4	467,0	7.500.184.930	95.3	577.0
2250	7.500.187.975	55.0	385.0	7.500.187.975	68.9	478.0	7.500.186.940	86.0	592,0	7.500.184.940	107.2	724.0
2500	7.500.187.980	61.2	475.0	7.500.187.980	76.6	584.0	7.500.186.950	95.6	729,0	7.500.184.950	119.1	900.0

PE 100 Borular

PE 100 Pipe Calculation Table

da mm	SDR 17 - PN 10			SDR 13.6 - PN 12.5			SDR 11 - PN 16			SDR 9 - PN 20			SDR 7.4 - PN 25		
	Code	S mm	Kg/m	Code	S mm	Kg/m	Code	S mm	Kg/m	Code	S mm	Kg/m	Code	S mm	Kg/m
20							7.500.176.020	2.00	0.112	7.500.172.020	2.30	0.133	7.500.171.020	3.00	0.154
25				7.500.175.025	2.00	0.152	7.500.176.025	2.30	0.171	7.500.172.025	3.00	0.220	7.500.171.025	3.50	0.240
32	7.500.180.032	2.00	0.187	7.500.175.032	2.40	0.232	7.500.176.032	3.00	0.272	7.500.172.032	3.60	0.327	7.500.171.032	4.40	0.386
40	7.500.180.040	2.40	0.295	7.500.175.040	3.00	0.356	7.500.176.040	3.70	0.430	7.500.172.040	4.50	0.509	7.500.171.040	5.50	0.600
50	7.500.180.050	3.00	0.453	7.500.175.050	3.70	0.549	7.500.176.050	4.60	0.666	7.500.172.050	5.60	0.788	7.500.171.050	6.90	0.936
63	7.500.180.063	3.80	0.721	7.500.175.063	4.70	0.873	7.500.176.063	5.80	1.050	7.500.172.063	7.10	1.260	7.500.171.063	8.60	1.470
75	7.500.180.075	4.50	1.020	7.500.175.075	5.60	1.240	7.500.176.075	6.80	1.470	7.500.172.075	8.40	1.760	7.500.171.075	10.3	2.090
90	7.500.180.090	5.40	1.460	7.500.175.090	6.70	1.770	7.500.176.090	8.20	2.120	7.500.172.090	10.1	2.540	7.500.171.090	12.3	3.000
110	7.500.180.110	6.60	2.170	7.500.175.110	8.10	2.620	7.500.176.110	10.0	3.140	7.500.172.110	12.3	3.780	7.500.171.110	15.1	4.490
125	7.500.180.125	7.40	2.760	7.500.175.125	9.20	3.370	7.500.176.125	11.4	4.080	7.500.172.125	14.0	4.870	7.500.171.125	17.1	5.770
140	7.500.180.140	8.30	3.460	7.500.175.140	10.3	4.220	7.500.176.140	12.7	5.080	7.500.172.140	15.7	6.110	7.500.171.140	19.2	7.250
160	7.500.180.160	9.50	4.520	7.500.175.160	11.8	5.500	7.500.176.160	14.6	6.670	7.500.172.160	17.9	7.960	7.500.171.160	21.9	9.440
180	7.500.180.180	10.7	5.710	7.500.175.180	13.3	6.980	7.500.176.180	16.4	8.420	7.500.172.180	20.1	10.10	7.500.171.180	24.6	11.90
200	7.500.180.200	11.9	7.050	7.500.175.200	14.7	8.560	7.500.176.200	18.2	10.40	7.500.172.200	22.4	12.40	7.500.171.200	27.4	14.80
225	7.500.180.225	13.4	8.930	7.500.175.225	16.6	10.90	7.500.176.225	20.5	13.10	7.500.172.225	25.2	15.80	7.500.171.225	30.8	18.60
250	7.500.180.250	14.8	11.00	7.500.175.250	18.4	13.40	7.500.176.250	22.7	16.20	7.500.172.250	27.9	19.40	7.500.171.250	34.2	23.00
280	7.500.180.280	16.6	13.70	7.500.175.280	20.6	16.80	7.500.176.280	25.4	20.30	7.500.172.280	31.3	24.30	7.500.171.280	38.3	28.90
315	7.500.180.315	18.7	17.40	7.500.175.315	22.2	21.20	7.500.176.315	28.6	25.60	7.500.172.315	35.2	30.80	7.500.171.315	43.1	36.50
355	7.500.180.355	21.1	22.10	7.500.175.355	26.1	26.90	7.500.176.355	32.2	32.50	7.500.172.355	39.7	39.10	7.500.171.355	48.5	46.30
400	7.500.180.400	23.7	28.00	7.500.175.400	29.4	34.10	7.500.176.400	36.3	41.30	7.500.172.400	44.7	49.60	7.500.171.400	54.7	58.80
450	7.500.180.450	26.7	35.40	7.500.175.450	33.1	43.20	7.500.176.450	40.9	52.30	7.500.172.450	50.3	62.70	7.500.171.450	61.5	74.40
500	7.500.180.500	29.7	43.80	7.500.175.500	36.8	53.30	7.500.176.500	45.4	64.50	7.500.172.500	55.8	77.30	7.500.171.500	68.3	91.80
560	7.500.180.560	33.2	54.80	7.500.175.560	41.2	66.90	7.500.176.560	50.8	80.80	7.500.172.560	62.5	97.00			
630	7.500.180.630	37.4	69.40	7.500.175.630	46.3	84.60	7.500.176.630	57.2	102.0	7.500.172.630	70.3	125.0			
710	7.500.180.710	42.1	88.00	7.500.175.710	52.2	107.0	7.500.176.710	64.5	130.0	7.500.172.710	79.3	160.0			
800	7.500.180.800	47.4	112.0	7.500.175.800	58.8	136.0	7.500.176.800	72.6	166.0	7.500.172.800	89.3	202.0			
900	7.500.180.900	53.3	141.0	7.500.175.900	66.1	173.0	7.500.176.900	81.7	210.0						
1000	7.500.180.910	59.3	175.0	7.500.175.910	73.4	215.0	7.500.176.910	90.8	259.0						
1200	7.500.180.912	71.1	262.0	7.500.175.912	88.2	304.0	7.500.176.912	109.1	375.0						
1400	7.500.180.915	83.0	341.0	7.500.175.915	102.9	423.0									
1600	7.500.180.918	94.8	453.0	7.500.175.918	117.5	552.0									
1800	7.500.180.920	106.6	573.0												
2000	7.500.180.922	118.4	707.0												
2250															
2500															

Produced only on special request.

Produced only on special request.

PE Pipes

Calculation tables

PE 80 Natural Gas Pipes

TS EN 1555-2
ISO 4437

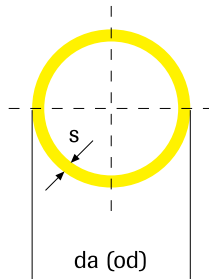

PE 100 Natural Gas Pipe Calculation Table

da mm	SDR 17.6			SDR 11		
	Code	S mm	Kg/m	Code	S mm	Kg/m
20	7.130.001.020	2.30	0.128	7.130.000.020	3.00	0.160
25	7.130.001.025	2.30	0.164	7.130.000.025	3.00	0.220
32	7.130.001.032	2.30	0.214	7.130.000.032	3.00	0.280
40	7.130.001.040	2.30	0.272	7.130.000.040	3.70	0.430
50	7.130.001.050	2.90	0.427	7.130.000.050	4.60	0.670
63	7.130.001.063	3.60	0.671	7.130.000.063	5.80	1.060
75	7.130.001.075	4.30	0.955	7.130.000.075	6.80	1.500
90	7.130.001.090	5.20	1.385	7.130.000.090	8.20	2.140
110	7.130.001.110	6.30	2.050	7.130.000.110	10.0	3.170
125	7.130.001.125	7.10	2.630	7.130.000.125	11.4	4.100
140	7.130.001.140	8.00	3.315	7.130.000.140	12.7	5.150
160	7.130.001.160	9.10	4.310	7.130.000.160	14.6	6.710
180	7.130.001.180	10.3	5.490	7.130.000.180	16.4	8.400
200	7.130.001.200	11.4	6.750	7.130.000.200	18.2	10.450
225	7.130.001.225	12.8	8.530	7.130.000.225	20.5	13.220
250	7.130.001.250	14.2	10.515	7.130.000.250	22.7	16.310
280	7.130.001.280	15.9	13.200	7.130.000.280	25.4	20.440
315	7.130.001.315	17.9	16.700	7.130.000.315	28.6	25.860
355	7.130.001.355	20.2	21.235	7.130.000.355	32.3	34.120
400	7.130.001.400	22.8	27.000	7.130.000.400	36.4	43.340
450	7.130.001.450	25.6	34.100	7.130.000.450	40.9	54.940
500	7.130.001.500	28.4	42.000	7.130.000.500	45.5	67.760
560	7.130.001.560	31.9	55.000	7.130.000.560	50.9	84.920
630	7.130.001.630	35.8	69.200	7.130.000.630	57.3	107.560

PE 80 Pipes

ISO 4427-2
TS EN 12201-2 + A1

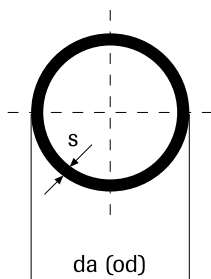

PE 80 Pipe Calculation Table

da mm	SDR 33 - PN 4			SDR 13.6 - PN 10			SDR 11 - PN 12.5			SDR 9 - PN 16			SDR 7.4 - PN 20		
	Code	S mm	Kg/m	Code	S mm	Kg/m	Code	S mm	Kg/m	Code	S mm	Kg/m	Code	S mm	Kg/m
20								2.00	0.112	7.500.221.020	2.30	0.133	7.500.222.020	3.00	0.154
25								2.30	0.171	7.500.221.025	3.00	0.220	7.500.222.025	3.50	0.240
32				7.500.220.032	2.40	0.232	7.500.212.032	3.00	0.272	7.500.221.032	3.60	0.327	7.500.222.032	4.40	0.386
40				7.500.220.040	3.00	0.356	7.500.212.040	3.70	0.430	7.500.221.040	4.50	0.509	7.500.222.040	5.50	0.600
50				7.500.220.050	3.70	0.549	7.500.212.050	4.60	0.666	7.500.221.050	5.60	0.788	7.500.222.050	6.90	0.936
63				7.500.220.063	4.70	0.873	7.500.212.063	5.80	1.050	7.500.221.063	7.10	1.260	7.500.222.063	8.60	1.470
75				7.500.220.075	5.60	1.240	7.500.212.075	6.80	1.470	7.500.221.075	8.40	1.760	7.500.222.075	10.3	2.090
90				7.500.220.090	6.70	1.770	7.500.212.090	8.20	2.120	7.500.221.090	10.1	2.540	7.500.222.090	12.3	3.000
110				7.500.220.110	8.10	2.620	7.500.212.110	10.0	3.140	7.500.221.110	12.3	3.780	7.500.222.110	15.1	4.490
125				7.500.220.125	9.20	3.370	7.500.212.125	11.4	4.080	7.500.221.125	14.0	4.870	7.500.222.125	17.1	5.770
140				7.500.220.140	10.3	4.220	7.500.212.140	12.7	5.080	7.500.221.140	15.7	6.110	7.500.222.140	19.2	7.250
160				7.500.220.160	11.8	5.500	7.500.212.160	14.6	6.670	7.500.221.160	17.9	7.960	7.500.222.160	21.9	9.440
180				7.500.220.180	13.3	6.980	7.500.212.180	16.4	8.420	7.500.221.180	20.1	10.10	7.500.222.180	24.6	11.90
200				7.500.220.200	14.7	8.560	7.500.212.200	18.2	10.40	7.500.221.200	22.4	12.40	7.500.222.200	27.4	14.80
225				7.500.220.225	16.6	10.90	7.500.212.225	20.5	13.10	7.500.221.225	25.2	15.80	7.500.222.225	30.8	18.60
250				7.500.220.250	18.4	13.40	7.500.212.250	22.7	16.20	7.500.221.250	27.9	19.40	7.500.222.250	34.2	23.00
280				7.500.220.280	20.6	16.80	7.500.212.280	25.4	20.30	7.500.221.280	31.3	24.30	7.500.222.280	38.3	28.90
315	7.500.218.315	9.70	9.370	7.500.220.315	32.2	21.20	7.500.212.315	28.6	25.60	7.500.221.315	35.2	30.80	7.500.222.315	43.1	36.50
355	7.500.218.355	10.9	11.80	7.500.220.355	26.1	26.90	7.500.212.355	32.2	32.50	7.500.221.355	39.7	39.10	7.500.222.355	48.5	46.30
400	7.500.218.400	12.3	15.10	7.500.220.400	29.4	34.10	7.500.212.400	36.3	41.30	7.500.221.400	44.7	49.60	7.500.222.400	54.7	54.80
450	7.500.218.450	13.8	19.00	7.500.220.450	33.1	43.20	7.500.212.450	40.9	52.30	7.500.221.450	50.3	62.70	7.500.222.450	61.5	74.40
500	7.500.218.500	15.3	23.40	7.500.220.500	36.8	53.30	7.500.212.500	45.4	64.50	7.500.221.500	55.8	77.30			
560	7.500.218.560	17.2	29.40	7.500.220.560	41.2	66.90	7.500.212.560	50.8	80.80						
630	7.500.218.630	19.3	37.10	7.500.220.630	46.3	84.60	7.500.212.630	57.2	102.0						
710	7.500.218.710	21.8	47.20	7.500.220.710	52.2	107.0	7.500.212.710								
800	7.500.218.800	24.5	59.70	7.500.220.800	58.8	136.0	7.500.212.800								
900	7.500.218.900	27.6	75.60												
1000	7.500.218.910	30.6	93.10												
1200	7.500.218.920	36.7	134.0												
1400	7.500.218.940	42.9	183.0												
1600	7.500.218.960	49.0	238.0												

PE Pipes

Calculation tables

PE 40 Pipes

TS EN 12201-2

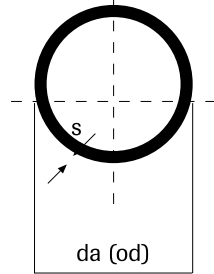

PE 40 pipes are generally used in municipal networks as intermediate passage pipes for building connections.

PE 40 Pipe Calculation Table

Outer Diameter	SDR 9 - PN 8		SDR 7.4 - PN 10	
	S mm	Kg/m	S mm	Kg/m
20	2.30	0.129	3.00	0.162
25	3.00	0.210	3.50	0.232
32	3.60	0.325	4.40	0.381
40	4.50	0.508	5.50	0.614
50	5.60	0.791	6.90	0.946
63	7.10	1.262	8.60	1.490
75	8.40	1.780	10.3	2.120
90	10.1	2.570	12.3	3.040
110	12.3	3.820	15.1	4.560

PE Pipe Fittings

Calculation Tables

PE 100 EF Coupler

ISO 4427-3 / TS EN 12201-3 + A1
 TS EN 1555-3 + A1 / DIN 16963
 DVGW GW 335 B 2

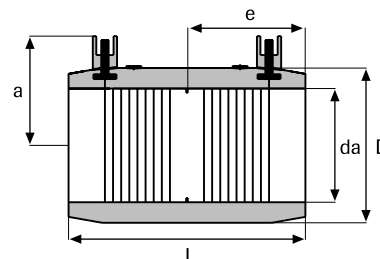

PE 100 EF Coupler Calculation Table*

da mm	L mm	e mm	D mm	a mm	SDR 11 - PN 16 Code
20	80	38	31	34	755.44.16.020.0
25	85	40	36	37	755.44.16.025.0
32	92	43	44	40	755.44.16.032.0
40	102	48	54	44	755.44.16.040.0
50	112	54	66	49	755.44.16.050.0
63	129	62	83	56	755.44.16.063.0
75	120	58	96	62	755.44.16.075.0
90	141	68	114	69	755.44.16.090.0
110	152	75	140	79	755.44.16.110.0
125	171	85	160	87	755.44.16.125.0
140	181	90	178	94	755.44.16.140.0
160	180	87	198	104	755.44.16.160.0
180	202	99	222	114	755.44.16.180.0
200	217	106	245	124	755.44.16.200.0
225	232	115	276	137	755.44.16.225.0

*Diameters between 20 mm - 225 mm are manufactured with injection method.

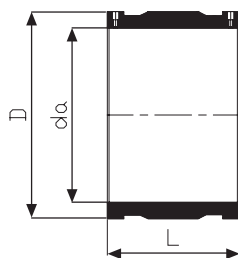

da mm	L mm	SDR 17 - PN 10		SDR 11 - PN 20		SDR 9 - PN 20		SDR 7.4 - PN 25	
		Code	S mm	Code	S mm	Code	S mm	Code	S mm
250	210	755.44.10.250.0	285	755.44.16.250.0	300	755.44.20.250.0	313	755.44.25.250.0	330
280	220	755.44.10.280.0	320	755.44.16.280.0	336	755.44.20.280.0	350	755.44.25.280.0	370
315	240	755.44.10.315.0	360	755.44.16.315.0	377	755.44.20.315.0	395	755.44.25.315.0	410
355	280	755.44.10.355.0	406	755.44.16.355.0	436	755.44.20.355.0	445	755.44.25.355.0	468
400	295	755.44.10.400.0	457	755.44.16.400.0	491	755.44.20.400.0	500	755.44.25.400.0	530
450	320	755.44.10.450.0	513	755.44.16.450.0	553	755.44.20.450.0	563	755.44.25.450.0	600
500	360	755.44.10.500.0	570	755.44.16.500.0	613	755.44.20.500.0	625		
560	390	755.44.10.560.0	640	755.44.16.560.0	687	755.44.20.560.0	700		
630	430	755.44.10.630.0	720	755.44.16.630.0	770	755.44.20.630.0	790		
710	450	755.44.10.710.0	810	755.44.16.710.0	860	755.44.20.710.0	890		
800	500	755.44.10.800.0	915	755.44.16.800.0	970	755.44.20.800.0	1000		
900	550	755.44.10.900.0	1030	755.44.16.900.0	1100				
1000	600	755.44.10.100.0	1140	755.44.16.100.0	1220				

PE Pipe Fittings

Calculation Tables

PE 100 EF Repair Adapter

ISO 4427-3
 TS EN 12201-3 + A1
 TS EN 1555-3 + A1

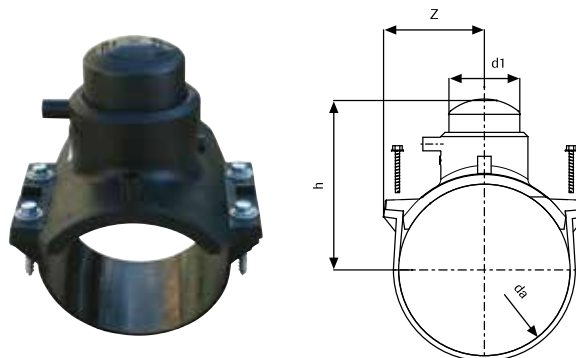

PE 100 EF Repair Adapter Calculation Table

da mm	L mm	e mm	D mm	a mm	SDR 11 - PN 16 Code
63	63	119	160	49	75.547.600.630
75	63	124	160	57	75.547.600.750
90	63	132	160	67	75.547.600.900
110	63	143	160	83	75.547.601.100
125	63	152	160	95	75.547.601.250
140	63	160	160	106	75.547.601.400
160	63	168	160	118	75.547.601.600
180	63	177	160	131	75.547.601.800
200	63	187	160	145	75.547.602.000
225	63	200	160	162	75.547.602.250

EF Service Tee Set Flat

ISO 4427-3
 TS EN 12201-3 + A1
 TS EN 1555-3 + A1

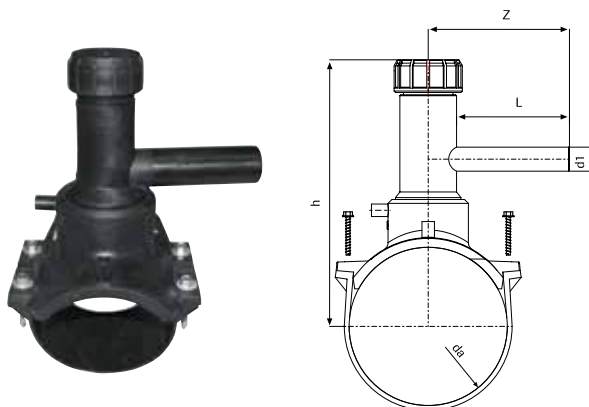

PE 100 EF Service Tee Set Flat Calculation Table

da mm	d1 mm	h mm	L mm	z mm	SDR 11 - PN 16 Code	da mm	d1 mm	h mm	L mm	z mm	SDR 11 - PN 16 Code
63	20	184	96	130	755.41.16.063.0	140	20	225	96	130	755.41.16.063.0
63	25	219	81	130	755.41.16.063.1	140	25	260	81	130	755.41.16.063.1
63	32	184	96	130	755.41.16.063.2	140	32	225	96	130	755.41.16.063.2
63	40	219	103	137	755.41.16.063.3	140	40	260	103	137	755.41.16.063.3
63	50	219	113	147	755.41.16.063.4	140	50	260	113	147	755.41.16.063.4
63	63	219	133	167	755.41.16.063.5	140	63	260	133	167	755.41.16.063.5
75	20	189	96	130	755.41.16.075.0	160	20	133	96	130	755.41.16.075.0
75	25	224	81	130	755.41.16.075.1	160	25	268	81	130	755.41.16.075.1
75	32	189	96	130	755.41.16.075.2	160	32	233	96	130	755.41.16.075.2
75	40	224	103	137	755.41.16.075.3	160	40	168	103	137	755.41.16.075.3
75	50	224	113	147	755.41.16.075.4	160	50	168	113	147	755.41.16.075.4
75	63	224	133	167	755.41.16.075.5	160	63	268	133	167	755.41.16.075.5
90	20	197	96	130	755.41.16.090.0	180	20	242	96	130	755.41.16.090.0
90	25	232	81	130	755.41.16.090.1	180	25	277	81	130	755.41.16.090.1
90	32	197	96	130	755.41.16.090.2	180	32	242	96	130	755.41.16.090.2
90	40	232	103	137	755.41.16.090.3	180	40	277	103	137	755.41.16.090.3
90	50	232	113	147	755.41.16.090.4	180	50	277	113	147	755.41.16.090.4
90	63	232	133	167	755.41.16.090.5	180	63	277	133	167	755.41.16.090.5
110	20	208	96	130	755.41.16.110.0	200	20	252	96	130	755.41.16.110.0
110	25	243	81	130	755.41.16.110.1	200	25	287	81	130	755.41.16.110.1
110	32	208	96	130	755.41.16.110.2	200	32	252	96	130	755.41.16.110.2
110	40	243	103	137	755.41.16.110.3	200	40	287	103	137	755.41.16.110.3
110	50	243	113	147	755.41.16.110.4	200	50	287	113	147	755.41.16.110.4
110	63	243	133	167	755.41.16.110.5	200	63	287	133	167	755.41.16.110.5
125	20	217	96	130	755.41.16.125.0	225	20	265	96	130	755.41.16.125.0
125	25	252	81	130	755.41.16.125.1	225	25	300	81	130	755.41.16.125.1
125	32	217	96	130	755.41.16.125.2	225	32	265	96	130	755.41.16.125.2
125	40	252	103	137	755.41.16.125.3	225	40	300	103	137	755.41.16.125.3
125	50	252	113	147	755.41.16.125.4	225	50	300	113	147	755.41.16.125.4
125	63	252	133	167	755.41.16.125.5	225	63	300	133	167	755.41.16.125.5

PE Pipe Fittings

Calculation Tables

EF Service Tee Set with Valve

ISO 4427-3
 TS EN 12201-3 + A1
 TS EN 1555-3 + A1

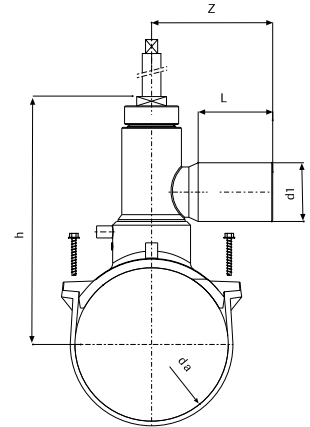

PE 100 EF Service Tee Set with Valve Calculation Table

da mm	d1 mm	h mm	L mm	z mm	SDR 11 - PN 16 Code	da mm	d1 mm	h mm	L mm	z mm	SDR 11 - PN 16 Code
63	20	192	80	130	755.40.16.063.0	140	20	233	80	130	755.40.16.140.0
63	25	192	80	130	755.40.16.063.1	140	25	233	80	130	755.40.16.140.1
63	32	192	80	130	755.40.16.063.2	140	32	233	80	130	755.40.16.140.2
63	40	192	80	137	755.40.16.063.3	140	40	233	80	130	755.40.16.140.3
63	50	192	80	147	755.40.16.063.4	140	50	233	80	130	755.40.16.140.4
63	63	192	80	167	755.40.16.063.5	140	63	233	80	130	755.40.16.140.5
75	20	197	80	130	755.40.16.075.0	160	20	241	80	130	755.40.16.160.0
75	25	197	80	130	755.40.16.075.1	160	25	241	80	130	755.40.16.160.1
75	32	197	80	130	755.40.16.075.2	160	32	241	80	130	755.40.16.160.2
75	40	197	80	137	755.40.16.075.3	160	40	241	80	130	755.40.16.160.3
75	50	197	80	147	755.40.16.075.4	160	50	241	80	130	755.40.16.160.4
75	63	197	80	167	755.40.16.075.5	160	63	241	80	130	755.40.16.160.5
90	20	205	80	130	755.40.16.090.0	180	20	250	80	130	755.40.16.180.0
90	25	205	80	130	755.40.16.090.1	180	25	250	80	130	755.40.16.180.1
90	32	205	80	130	755.40.16.090.2	180	32	250	80	130	755.40.16.180.2
90	40	205	80	137	755.40.16.090.3	180	40	250	80	130	755.40.16.180.3
90	50	205	80	147	755.40.16.090.4	180	50	250	80	130	755.40.16.180.4
90	63	205	80	167	755.40.16.090.5	180	63	250	80	130	755.40.16.180.5
110	20	216	80	130	755.40.16.110.0	200	20	260	80	130	755.40.16.200.0
110	25	216	80	130	755.40.16.110.1	200	25	260	80	130	755.40.16.200.1
110	32	216	80	130	755.40.16.110.2	200	32	260	80	130	755.40.16.200.2
110	40	216	80	137	755.40.16.110.3	200	40	260	80	130	755.40.16.200.3
110	50	216	80	147	755.40.16.110.4	200	50	260	80	130	755.40.16.200.4
110	63	216	80	167	755.40.16.110.5	200	63	260	80	130	755.40.16.200.5
125	20	225	80	130	755.40.16.125.0	225	20	273	80	130	755.40.16.225.0
125	25	225	80	130	755.40.16.125.1	225	25	273	80	130	755.40.16.225.1
125	32	225	80	130	755.40.16.125.2	225	32	273	80	130	755.40.16.225.2
125	40	225	80	137	755.40.16.125.3	225	40	273	80	130	755.40.16.225.3
125	50	225	80	147	755.40.16.125.4	225	50	273	80	130	755.40.16.225.4
125	63	225	80	167	755.40.16.125.5	225	63	273	80	130	755.40.16.225.5

PE 100 EF 90° Elbow

ISO 4427-3
 TS EN12201-3
 TS EN 1555-3

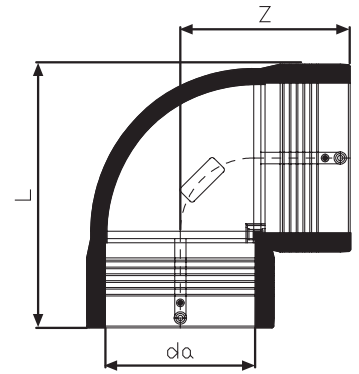

PE 100 EF 90° Elbow Calculation Table

da mm	L mm	Z mm	SDR 11 - PN 16 Code
50	112	80.5	755.46.00.405.0
110	221	145	755.46.00.411.0
125	227	150	755.46.00.412.5
160	279	179	755.46.00.416.0
200	341	217.5	755.46.00.420.0

PE 100 EF 45° Elbow

ISO 4427-3
 TS EN12201-3
 TS EN 1555-3

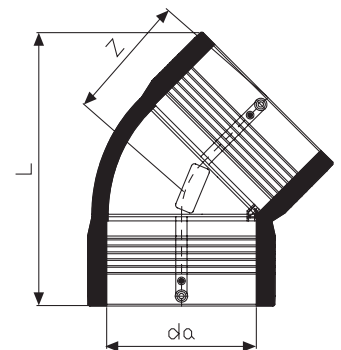

PE 100 EF 45° Elbow Calculation Table

da mm	L mm	Z mm	SDR 11 - PN 16 Code
50	134.6	67.3	755.46.00.405.0
75	173	86.5	755.46.00.411.0
160	258	129	755.46.00.412.5
200	317	158.5	755.46.00.416.0

PE Pipe Fittings

Calculation Tables

PE 100 EF TEE

ISO 4427-3
 TS EN12201-3
 TS EN 1555-3

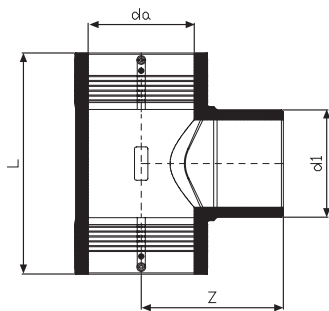

PE 100 EF TEE Calculation Table

da mm	d1 mm	L mm	Z mm	SDR 11 - PN 16 Code
50	50	150	96.5	755.14.16.105.0
75	75	200	125	755.14.16.107.5
110	110	248	161	755.14.16.110.0
125	125	294	175	755.14.16.112.5
160	160	330	227	755.14.16.116.0
200	200	390	252	755.14.16.120.0

PE 100 EF Inegal TEE

ISO 4427-3
 TS EN12201-3
 TS EN 1555-3

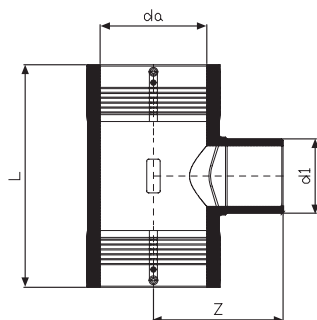

PE 100 EF Inegal TEE Calculation Table

da mm	d1 mm	Z mm	SDR 11 - PN 16 Code
75	63	117	755.46.07.506.3
110	63	140	755.46.11.006.3
110	75	148	755.46.11.007.5
110	90	159	755.46.11.009.0
125	63	146	755.61.26.06.3
125	75	156	755.61.25.07.5
125	90	169	755.61.25.19.0
125	110	171	755.61.25.11.0
160	63	172	755.61.60.06.3
160	75	180	755.61.60.07.5
160	90	191	755.61.60.09.0
160	110	192	755.61.60.11.0
200	63	195	755.62.00.06.3
200	75	203	755.62.00.07.5
200	90	214	755.62.00.09.0
200	110	216	755.62.00.11.0
200	125	220	755.62.00.12.5
200	160	236	755.62.00.16.0

PE 100 End Cap

ISO 4427-3
 TS EN 12201-3 + A1
 TS EN 1555-3 + A1
 DVGW GW 335-B2

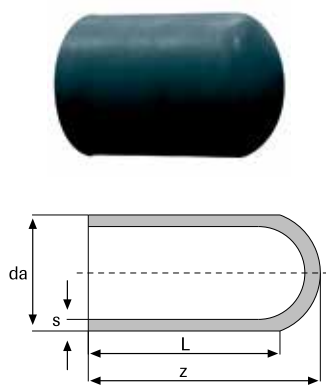

PE 100 End Cap Calculation Table

da mm	s mm	L mm	z mm	SDR 11 - PN 16 Code
20	3.0	42	47	755.17.16.020.0
25	3.0	42	48	755.17.16.025.0
32	3.0	45	52	755.17.16.032.0
40	3.7	50	61	755.17.16.040.0
50	4.6	55	71	755.17.16.050.0
63	5.8	65	81	755.17.16.063.0
75	6.8	75	91	755.17.16.075.0
90	8.2	84	107	755.17.16.090.0
110	10.0	84	109	755.17.16.110.0
125	11.4	89	118	755.17.16.125.0
140	12.7	92	126	755.17.16.140.0
160	14.6	98	137	755.17.16.160.0
180	16.4	115	150	755.17.16.180.0
200	18.2	122	161	755.17.16.200.0
225	20.5	133	170	755.17.16.225.0
250	22.7	130	209	755.17.16.250.0
280	25.4	139	230	755.17.16.280.0
315	28.6	150	240	755.17.16.315.0

PE 100 EF End Cap

ISO 4427-3
 TS EN 12201-3+A1
 TS EN 1555-3+A1
 DVGW GW 335-B2

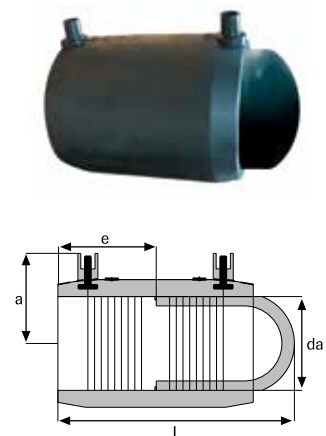

PE 100 EF End Cap Calculation Table

da mm	a mm	L mm	e mm	SDR 11 - PN 16 Code
20	34	74	40	755.45.16.020.0
25	37	80	40	755.45.16.025.0
32	40	90	43	755.45.16.032.0
40	44	102	48	755.45.16.040.0
50	49	116	54	755.45.16.050.0
63	56	137	62	755.45.16.063.0
75	62	151	68	755.45.16.075.0
90	69	178	70	755.45.16.090.0
110	79	200	75	755.45.16.110.0
125	87	218	85	755.45.16.125.0
140	94	235	90	755.45.16.140.0
160	102	260	90	755.45.16.160.0
180	114	294	99	755.45.16.180.0
200	124	305	106	755.45.16.200.0
225	137	329	115	755.45.16.225.0

PE Pipe Fittings

Calculation Tables

PE 100 Steel Transition Adapter Female

DIN 2999

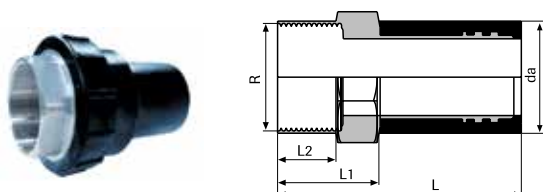

PE 100 Steel Transition Adapter Female Calculation Table

da mm	R mm	L mm	L1 mm	L1 mm	SDR 11 - PN 16 Code
20	1/2"	89	50	8	755.32.16.020.0
25	3/4"	91	50	8	755.32.16.025.0
32	1"	104	59	9	755.32.16.032.0
40	1.1/4"	128	68	10	755.32.16.040.0
50	1.1/2"	138	74	12	755.32.16.050.0
63	2"	152	80	14	755.32.16.063.0
75	2.1/2"	163	84	20	755.32.16.075.0

PE 100 Steel Transition Adapter Male

DIN 2999

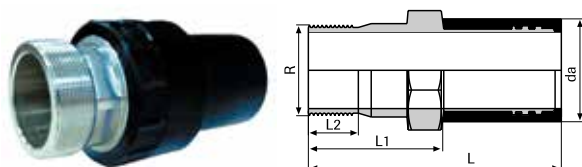

PE 100 Steel Transition Adapter Male Calculation Table

da mm	R mm	L mm	L1 mm	L1 mm	SDR 11 - PN 16 Code
20	1/2"	103	64	20	755.34.16.020.0
25	3/4"	105	64	22	755.34.16.025.0
32	1"	117	72	25	755.34.16.032.0
40	1.1/4"	144	84	28	755.34.16.040.0
50	1.1/2"	152	88	34	755.34.16.050.0
63	2"	176	104	42	755.34.16.063.0
75	2.1/2"	187	108	52	755.34.16.063.0

PE 100 Welded Steel Transition Adapter

DIN 2999

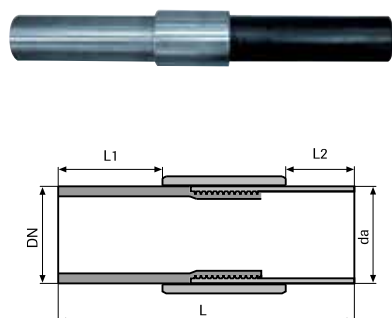

PE 100 Welded Steel Transition Adapter Calculation Table

da mm	R mm	L mm	L1 mm	L1 mm	SDR 11 - PN 16 Code
20	16	420	180	180	755.30.16.020.0
25	20	430	180	180	755.30.16.025.0
32	25	480	200	200	755.30.16.032.0
40	32	490	200	200	755.30.16.040.0
50	40	500	200	200	755.30.16.050.0
63	50	510	200	200	755.30.16.063.0
75	65	640	250	250	755.30.16.075.0
90	80	660	250	250	755.30.16.090.0
110	100	760	300	300	755.30.16.110.0

PE 100 90° Elbow (Injection)

ISO 4427-3
 TS EN 12201-3 + A1
 TS EN 1555-3 + A1

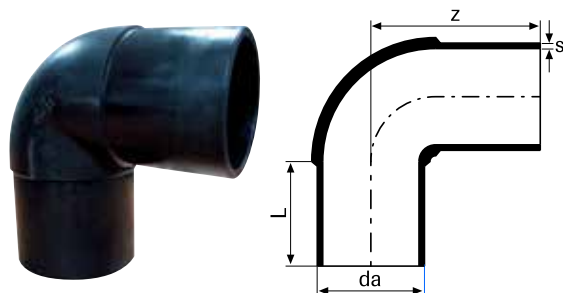

PE 100 90° Elbow (Injection) Calculation Table

da mm	L mm	z mm	SDR 17 - PN 10		SDR 11 - PN 16	
			Code	S mm	Code	S mm
20	41	57			755.04.16.020.0	3.00
25	41	60			755.04.16.025.0	3.00
32	44	67			755.04.16.032.0	3.00
40	40	77			755.04.16.040.0	3.70
50	55	90			755.04.16.050.0	4.60
63	63	106	755.04.10.063.0	3.80	755.04.16.063.0	5.80
75	70	119	755.04.10.075.0	4.50	755.04.16.075.0	6.80
90	79	137	755.04.10.090.0	5.40	755.04.16.090.0	8.20
110	82	153	755.04.10.110.0	6.60	755.04.16.110.0	10.0
125	87	170	755.04.10.125.0	7.40	755.04.16.125.0	11.4
140	92	190	755.04.10.140.0	8.30	755.04.16.140.0	12.7
160	98	201	755.04.10.160.0	9.50	755.04.16.160.0	14.6
180	105	230	755.04.10.180.0	10.7	755.04.16.180.0	16.4
200	112	241	755.04.10.200.0	11.9	755.04.16.200.0	18.2
225	120	265	755.04.10.225.0	13.4	755.04.16.225.0	20.5
250	130	287	755.04.10.250.0	14.8	755.04.16.250.0	22.7
280	139	315	755.04.10.280.0	16.6	755.04.16.280.0	25.4
315	150	345	755.04.10.315.0	18.7	755.04.16.315.0	28.6

PE 100 90° Elbow (Fabricated)

DIN 16963
 TS EN 12201-3 + A1

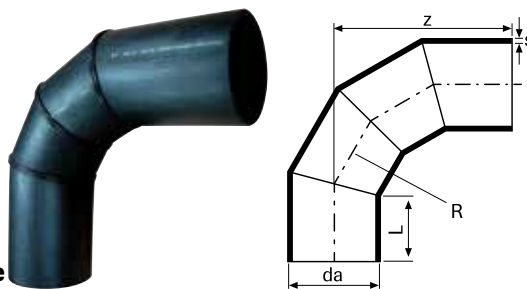

PE 100 90° Elbow (Fabricated) Calculation Table

da mm	L mm	R mm	z mm	SDR 26 - PN 6		SDR 17 - PN 10		SDR 11 - PN 16	
				Code	S mm	Code	S mm	Code	S mm
250	130	375	429	755.04.06.250.0	9.60	755.04.10.250.0	14.80	755.04.16.250.0	22.7
280	139	420	473	755.04.06.280.0	10.7	755.04.10.280.0	16.60	755.04.16.280.0	25.4
315	150	473	526	755.04.06.315.0	12.1	755.04.10.315.0	18.70	755.04.16.315.0	28.6
355	165	533	619	755.04.06.355.0	13.6	755.04.10.355.0	21.10	755.04.16.355.0	32.2
400	180	600	658	755.04.06.400.0	15.3	755.04.10.400.0	23.70	755.04.16.400.0	36.3
450	195	675	733	755.04.06.450.0	17.2	755.04.10.450.0	26.70	755.04.16.450.0	40.9
500	215	750	812	755.04.06.500.0	19.1	755.04.10.500.0	29.70	755.04.16.500.0	45.4
560	235	840	904	755.04.06.560.0	21.4	755.04.10.560.0	33.20	755.04.16.560.0	50.8
630	255	945	1008	755.04.06.630.0	24.1	755.04.10.630.0	37.40	755.04.16.630.0	57.2
710	280	1065	1128	755.04.06.710.0	27.2	755.04.10.710.0	42.10	755.04.16.710.0	64.5
800	280	1200	1236	755.04.06.800.0	30.6	755.04.10.800.0	47.40	755.04.16.800.0	72.6
900	280	1350	1355	755.04.06.900.0	34.4	755.04.10.900.0	53.30	755.04.16.900.0	81.7
1000	300	1500	1495	755.04.06.910.0	38.2	755.04.10.910.0	59.30	755.04.16.910.0	90.8
1200	300	1800	1734	755.04.06.920.0	45.9	755.04.10.920.0	71.10	755.04.16.920.0	109.1
1400	400	2100	2072	755.04.06.940.0	53.5	755.04.06.940.0	83.00		
1600	400	2400	2311	755.04.06.960.0	61.2	755.04.06.960.0	94.80		

PE Pipe Fittings

Calculation Tables

PE 100 60° Elbow (Fabricated)

DIN 16963

TS EN 12201-3 + A1

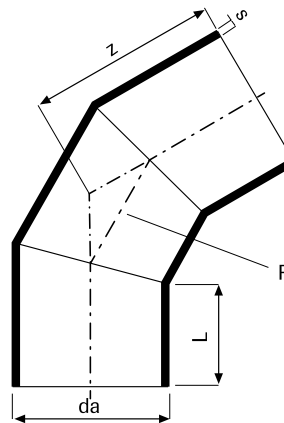

PE 100 60° Elbow (Fabricated) Calculation Table

da mm	L mm	R mm	z mm	SDR 26 - PN 6		SDR 17 - PN 10		SDR 11 - PN 16	
				Code	S mm	Code	S mm	Code	S mm
90	79	130	131	755.03.06.090.0	3.50	755.03.10.090.0	5.40	755.03.16.090.0	8.20
110	82	165	146	755.03.06.110.0	4.20	755.03.10.110.0	6.60	755.03.16.110.0	10.0
125	87	188	160	755.03.06.125.0	4.80	755.03.10.125.0	7.40	755.03.16.125.0	11.4
140	92	210	174	755.03.06.140.0	5.40	755.03.10.140.0	8.30	755.03.16.140.0	12.7
160	98	240	191	755.03.06.160.0	6.20	755.03.10.160.0	9.50	755.03.16.160.0	14.6
180	105	270	210	755.03.06.180.0	6.90	755.03.10.180.0	10.7	755.03.16.180.0	16.4
200	112	300	228	755.03.06.200.0	7.70	755.03.10.200.0	11.9	755.03.16.200.0	18.2
225	120	338	251	755.03.06.225.0	8.60	755.03.10.225.0	13.4	755.03.16.225.0	20.5
250	130	375	276	755.03.06.250.0	9.60	755.03.10.250.0	14.8	755.03.16.250.0	22.7
280	139	420	302	755.03.06.280.0	10.7	755.03.10.280.0	16.6	755.03.16.280.0	25.4
315	150	473	333	755.03.06.315.0	12.1	755.03.10.315.0	18.7	755.03.16.315.0	28.6
355	165	533	372	755.03.06.355.0	13.6	755.03.10.355.0	21.1	755.03.16.355.0	32.2
400	180	600	413	755.03.06.400.0	15.3	755.03.10.400.0	23.7	755.03.16.400.0	36.3
450	195	675	457	755.03.06.450.0	17.2	755.03.10.450.0	26.7	755.03.16.450.0	40.9
500	215	750	506	755.03.06.500.0	19.1	755.03.10.500.0	29.7	755.03.16.500.0	45.4
560	235	840	561	755.03.06.560.0	21.4	755.03.10.560.0	33.2	755.03.16.560.0	50.8
630	255	945	622	755.03.06.630.0	24.1	755.03.10.630.0	37.4	755.03.16.630.0	57.2
710	280	1065	680	755.03.06.710.0	27.2	755.03.10.710.0	42.1	755.03.16.710.0	64.5
800	280	1200	746	755.03.06.800.0	30.6	755.03.10.800.0	47.4	755.03.16.800.0	72.7
900	280	1350	804	755.03.06.900.0	34.4	755.03.10.900.0	53.3	755.03.16.900.0	81.7
1000	300	1500	882	755.03.06.910.0	38.2	755.03.10.910.0	59.3	755.03.16.910.0	90.8
1200	300	1800	1000	755.03.06.920.0	45.9	755.03.10.920.0	71.1	755.03.16.012.0	109.1
1499	400	2100	1215	755.03.06.940.0	53.5	755.03.06.940.0	83.0		
1600	400	2400	1332	755.03.06.960.0	61.2	755.03.06.980.0	94.8		

PE 100 45° Elbow (Injection)

ISO 4427-3
 TS EN 12201-3 + A1
 TS EN 1555 + A1

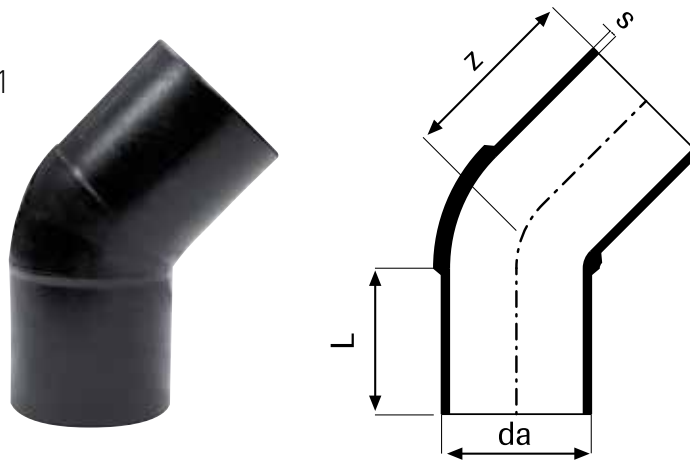

PE 100 45° Elbow (Injection) Calculation Table

da mm	L mm	z mm	SDR 17 - PN 10		SDR 11 - PN 16	
			Code	S mm	Code	S mm
20	41	48			755.02.16.020.0	3.00
25	44	50			755.02.16.025.0	3.00
32	44	54			755.02.16.032.0	3.00
40	49	60			755.02.16.040.0	3.70
50	55	72			755.02.16.050.0	4.60
63	64	80	755.02.10.063.0	3.80	755.02.16.063.0	5.80
75	70	95	755.02.10.075.0	4.50	755.02.16.075.0	6.80
90	80	104	755.02.10.090.0	5.40	755.02.16.090.0	8.20
110	82	110	755.02.10.110.0	6.60	755.02.16.110.0	10.0
125	90	121	755.02.10.125.0	7.40	755.02.16.125.0	11.4
140	92	150	755.02.10.140.0	8.30	755.02.16.140.0	12.7
160	98	140	755.02.10.160.0	9.50	755.02.16.160.0	14.6
180	105	185	755.02.10.180.0	10.7	755.02.16.180.0	16.4
200	190	167	755.02.10.200.0	11.9	755.02.16.200.0	18.2
225	120	265	755.02.10.225.0	13.4	755.02.16.225.0	20.5
250	130	200	755.02.10.250.0	14.8	755.02.16.250.0	22.7
280	139	216	755.02.10.280.0	16.6	755.02.16.280.0	25.4
315	150	240	755.02.10.315.0	18.7	755.02.16.315.0	28.6

PE Pipe Fittings

Calculation Tables

PE 100 45° Elbow (Fabricated)

ISO 4427-3

TS EN 12201-3 + A1

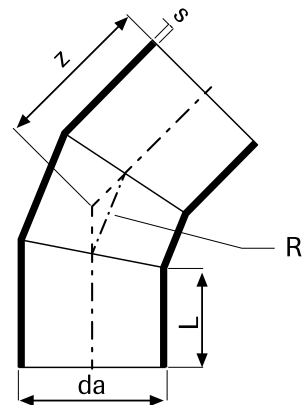

PE 100 45° Elbow (Fabricated) Calculation Table

da mm	L mm	R mm	z mm	SDR 26 - PN 6		SDR 17 - PN 10		SDR 11 - PN 16	
				Code	S mm	Code	S mm	Code	S mm
250	130	375	234	755.02.06.250.0	9.60	755.02.10.250.0	14.8	755.02.16.250.0	22.7
280	139	420	256	755.02.06.280.0	10.7	755.02.10.280.0	16.6	755.02.16.280.0	25.4
315	150	473	281	755.02.06.315.0	12.1	755.02.10.315.0	18.7	755.02.16.315.0	28.6
355	165	533	313	755.02.06.355.0	13.6	755.02.10.355.0	21.1	755.02.16.355.0	32.2
400	180	600	346	755.02.06.400.0	15.3	755.02.10.400.0	23.7	755.02.16.400.0	36.3
450	195	675	382	755.02.06.450.0	17.2	755.02.10.450.0	26.7	755.02.16.450.0	40.9
500	215	750	423	755.02.06.500.0	19.1	755.02.10.500.0	29.7	755.02.16.500.0	45.4
560	235	840	468	755.02.06.560.0	21.4	755.02.10.560.0	33.2	755.02.16.560.0	50.0
630	255	945	517	755.02.06.630.0	24.1	755.02.10.630.0	37.4	755.02.16.630.0	57.2
710	280	1065	576	755.02.06.710.0	27.2	755.02.10.710.0	42.1	755.02.16.710.0	64.5
800	280	1200	613	755.02.06.800.0	30.6	755.02.10.800.0	47.4	755.02.16.800.0	72.7
900	280	1350	655	755.02.06.900.0	34.4	755.02.10.900.0	53.3	755.02.16.900.0	81.7
1000	300	1500	716	755.02.06.910.0	38.2	755.02.10.910.0	59.3	755.02.16.010.0	90.8
1200	300	1800	789	755.02.06.920.0	45.9	755.02.10.920.0	71.1	755.02.16.012.0	109.1
1400	400	2100	983	755.02.06.940.0	53.5	755.02.10.940.0	83.0		
1600	400	2400	1066	755.02.06.960.0	61.2	755.02.10.960.0	94.8		

PE 100 30° Elbow (Fabricated)

ISO 4427-3
TS EN 12201-3 + A1
DIN 16963

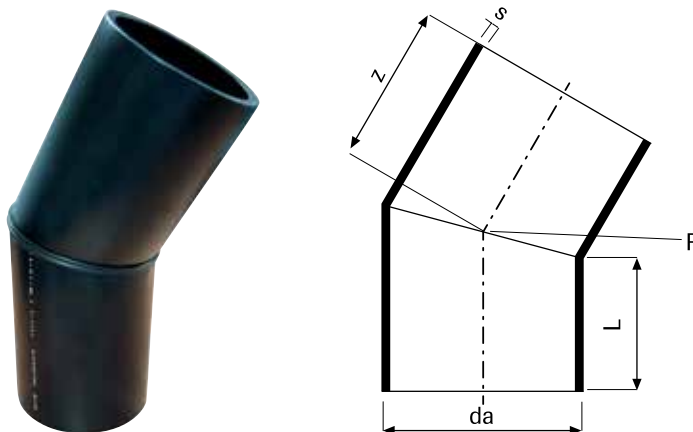

PE 100 30° Elbow (Fabricated) Calculation Table

da mm	L mm	R mm	z mm	SDR 26 - PN 6		SDR 17 - PN 10		SDR 11 - PN 16	
				Code	S mm	Code	S mm	Code	S mm
90	79	130	91	755.03.06.090.0	3.50	755.03.10.090.0	5.40	755.03.16.090.0	8.20
110	82	165	97	755.03.06.110.0	4.20	755.03.10.110.0	6.60	755.03.16.110.0	10.0
125	87	188	104	755.03.06.125.0	4.80	755.03.10.125.0	7.40	755.03.16.125.0	11.4
140	92	210	110	755.03.06.140.0	5.40	755.03.10.140.0	8.30	755.03.16.140.0	12.7
160	98	240	119	755.03.06.160.0	6.20	755.03.10.160.0	9.50	755.03.16.160.0	14.6
180	105	270	129	755.03.06.180.0	6.90	755.03.10.180.0	10.7	755.03.16.180.0	16.4
200	112	300	138	755.03.06.200.0	7.70	755.03.10.200.0	11.9	755.03.16.200.0	18.2
225	120	338	150	755.03.06.225.0	8.60	755.03.10.225.0	13.4	755.03.16.225.0	20.5
250	130	375	163	755.03.06.250.0	9.60	755.03.10.250.0	14.8	755.03.16.250.0	22.7
280	139	420	176	755.03.06.280.0	10.7	755.03.10.280.0	16.6	755.03.16.280.0	25.4
315	150	473	192	755.03.06.315.0	12.1	755.03.10.315.0	18.7	755.03.16.315.0	28.6
355	165	533	212	755.03.06.355.0	13.6	755.03.10.355.0	21.1	755.03.16.355.0	32.2
400	180	600	233	755.03.06.400.0	15.3	755.03.10.400.0	23.7	755.03.16.400.0	36.3
450	195	675	255	755.03.06.450.0	17.2	755.03.10.450.0	26.7	755.03.16.450.0	40.9
500	215	750	282	755.03.06.500.0	19.1	755.03.10.500.0	29.7	755.03.16.500.0	45.4
560	235	840	310	755.03.06.560.0	21.4	755.03.10.560.0	33.2	755.03.16.560.0	50.8
630	255	945	340	755.03.06.630.0	24.1	755.03.10.630.0	37.4	755.03.16.630.0	57.2
710	280	1065	375	755.03.06.710.0	27.2	755.03.10.710.0	42.1	755.03.16.710.0	64.5
800	280	1200	387	755.03.06.800.0	30.6	755.03.10.800.0	47.4	755.03.16.800.0	72.7
900	280	1350	400	755.03.06.900.0	34.4	755.03.10.900.0	53.3	755.03.16.900.0	81.7
1000	300	1500	434	755.03.06.910.0	38.2	755.03.10.910.0	59.3	755.03.16.910.0	90.8
1200	300	1800	461	755.03.06.920.0	45.9	755.03.10.920.0	71.1	755.03.16.920.0	109.1
1400	400	2100	587	755.03.06.940.0	53.5	755.03.10.940.0	83.0		
1600	400	2400	614	755.03.06.960.0	61.2	755.03.10.960.0	94.8		

PE Pipe Fittings

Calculation Tables

PE 100 Reducing TEE (Injection)

ISO 4427-3
TS EN 12201-3 + A1

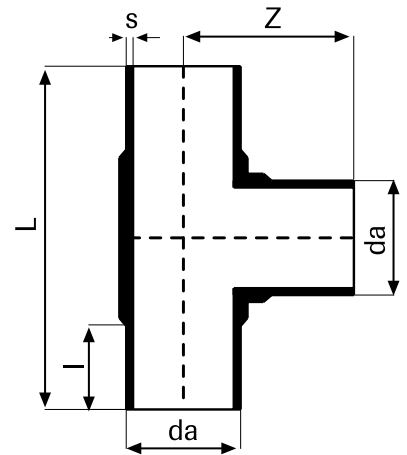

PE 100 Reducing Tee (Injection) Calculation Table

da mm	L mm	I mm	z mm	SDR 17 - PN 110		SDR 11 - PN 16	
				Code	S mm	Code	S mm
20	115	41	67.5			755.14.16.020.0	3.00
25	120	41	72.5			755.14.16.025.0	3.00
32	135	44	83.0			755.14.16.032.0	3.00
40	155	49	97.0			755.14.16.040.0	3.70
50	181	55	91.0	755.14.10.050.0	3.0	755.14.16.050.0	4.60
63	224	63	112	755.14.10.063.0	3.8	755.14.16.063.0	5.80
75	242	70	121	755.14.10.075.0	4.5	755.14.16.075.0	6.80
90	290	79	145	755.14.10.090.0	5.4	755.14.16.090.0	8.20
110	313	82	158	755.14.10.110.0	6.6	755.14.16.110.0	10.0
125	345	87	171	755.14.10.125.0	7.4	755.14.16.125.0	11.4
140	380	92	190	755.14.10.140.0	8.3	755.14.16.140.0	12.7
160	401	98	200	755.14.10.160.0	9.5	755.14.16.160.0	14.6
180	450	105	225	755.14.10.180.0	10.7	755.14.16.180.0	16.4
200	483	112	241	755.14.10.200.0	11.9	755.14.16.200.0	18.2
225	530	120	265	755.14.10.225.0	13.4	755.14.16.225.0	20.5
250	575	130	287	755.14.10.250.0	14.8	755.14.16.250.0	22.7
280	630	139	315	755.14.10.280.0	16.6	755.14.16.280.0	25.4
315	690	150	345	755.14.10.315.0	18.7	755.14.16.315.0	28.6

PE 100 Reducing TEE (Fabricated)

ISO 4427-3
TS EN 12201-3 + A1

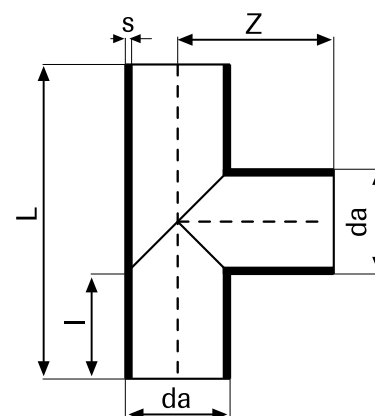

PE 100 Reducing Tee (Fabricated) Calculation Table

da mm	L mm	l mm	z mm	SDR 26 - PN 6		SDR 17 - PN 10		SDR 11 - PN 16	
				Code	S mm	Code	S mm	Code	S mm
250	575	155	280	755.14.06.250.0	9.60	755.14.10.250.0	14.8	755.14.16.250.0	22.7
280	595	155	295	755.14.06.280.0	10.7	755.14.10.280.0	16.6	755.14.16.280.0	25.4
315	665	170	327	755.14.06.315.0	12.1	755.14.10.315.0	18.7	755.14.16.315.0	28.6
355	725	175	352	755.14.06.355.0	13.6	755.14.10.355.0	21.1	755.14.16.355.0	32.2
400	785	180	380	755.14.06.400.0	15.3	755.14.10.400.0	23.7	755.14.16.400.0	36.3
450	890	210	435	755.14.06.450.0	17.2	755.14.10.450.0	26.7	755.14.16.450.0	40.9
500	1010	245	495	755.14.06.500.0	19.1	755.14.10.500.0	29.7	755.14.16.500.0	45.4
560	1055	250	530	755.14.06.560.0	21.4	755.14.10.560.0	33.2	755.14.16.560.0	50.8
630	1185	270	585	755.14.06.630.0	24.1	755.14.10.630.0	37.4	755.14.16.630.0	57.2
710	1280	280	635	755.14.06.710.0	27.2	755.14.10.710.0	42.1	755.14.16.710.0	64.5
800	1375	280	680	755.14.06.800.0	30.6	755.14.10.800.0	47.4	755.14.16.800.0	72.7
900	1485	285	735	755.14.06.900.0	34.4	755.14.10.900.0	53.3	755.14.16.900.0	81.8
1000	1620	300	800	755.14.06.910.0	38.2	755.14.10.910.0	59.3	755.14.16.910.0	90.9
1200	1830	300	900	755.14.06.920.0	45.9	755.14.10.920.0	71.1		

PE Pipe Fittings

Calculation Tables

PE 100 İnegal TEE (Injection)

ISO 4427-3
 TS EN 12201-3 + A1
 DIN 16963

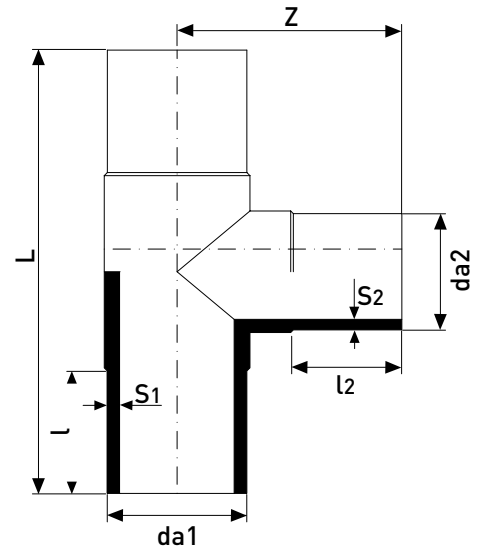

PE 100 İnegal TEE (Injection) Calculation Table

da1 mm	da2 mm	L mm	l1 mm	l2 mm	z mm	SDR 17 - PN 10			SDR 11 - PN 16		
						Code	S1 mm	S2 mm	Code	S1 mm	S2 mm
63	50	200	63	55	96	755.15.10.066.3	3,80	3,00	755.15.16.065.0	5,80	4,60
75	50	242	70	55	102	755.10.10.077.5	4,50	3,00	755.15.16.075.5	6,80	4,60
75	63	242	70	63	112	755.15.10.067.6	4,50	3,80	755.15.16.075.6	6,80	5,80
90	63	286	79	63	135	755.15.10.099.0	5,40	3,80	755.15.16.090.7	8,20	5,80
90	75	286	79	70	145	755.15.10.099.1	5,40	4,50	755.15.16.090.6	8,20	6,80
110	63	291	82	63	130	755.15.10.116.4	6,60	3,80	755.15.16.116.3	10,00	5,80
110	75	291	82	70	140	755.15.10.117.6	6,60	4,50	755.15.16.117.5	10,00	6,80
110	90	291	82	79	151	755.15.10.119.1	6,60	5,40	755.15.16.119.0	10,00	8,20
125	63	331	87	63	138	755.15.10.120.4	7,40	3,80	755.15.16.125.4	11,40	5,80
125	75	331	87	70	147	755.15.10.124.1	7,40	4,50	755.15.16.125.5	11,40	6,80
125	90	331	87	79	159	755.15.10.125.1	7,40	5,40	755.15.16.125.6	11,40	8,20
125	110	331	87	82	164	755.15.10.125.2	7,40	6,60	755.15.16.125.7	11,40	10,00
140	63	380	92	63	165	755.15.10.140.1	8,30	3,80	755.15.16.141.2	12,70	5,80
140	75	380	92	70	170	755.15.10.140.2	8,30	4,50	755.15.16.141.3	12,70	6,80
140	90	380	92	79	180	755.15.10.140.3	8,30	5,40	755.15.16.141.4	12,70	8,20
140	110	380	92	82	180	755.15.10.140.4	8,30	6,60	755.15.16.141.5	12,70	10,00
140	125	380	92	87	185	755.15.10.140.5	8,30	7,40	755.15.16.141.6	12,70	11,40
160	63	401	98	63	156	755.15.10.160.8	9,50	3,80	755.15.16.160.8	14,60	5,80
160	75	401	98	70	165	755.15.10.160.9	9,50	4,50	755.15.16.160.9	14,60	6,80
160	90	401	98	79	177	755.15.10.161.0	9,50	5,40	755.15.16.161.0	14,60	8,20
160	110	401	98	82	182	755.15.10.161.1	9,50	6,60	755.15.16.161.2	14,60	10,00
160	125	401	98	87	188	755.15.10.161.2	9,50	7,40	755.15.16.161.3	14,60	11,40
160	140	401	98	92	194	755.15.10.161.3	9,50	8,30	755.15.16.161.4	14,60	12,70

PE 100 Inegal TEE (Injection) Calculation Table

da1 mm	da2 mm	L mm	l1 mm	l2 mm	z mm	SDR 17 - PN 10			SDR 11 - PN 16		
						Code	S1 mm	S2 mm	Code	S1 mm	S2 mm
180	63	450	105	63	195	755.15.10.180.1	10,70	3,80	755.15.16.180.0	16,40	5,80
180	75	450	105	70	200	755.15.10.180.2	10,70	4,50	755.15.16.180.1	16,40	6,80
180	90	450	105	79	205	755.15.10.180.3	10,70	5,40	755.15.16.180.2	16,40	8,20
180	110	450	105	82	210	755.15.10.180.4	10,70	6,60	755.15.16.180.3	16,40	10,00
180	125	450	105	87	215	755.15.10.180.5	10,70	7,40	755.15.16.180.4	16,40	11,40
180	140	450	105	92	220	755.15.10.180.6	10,70	8,30	755.15.16.180.5	16,40	12,70
180	160	450	105	98	220	755.15.10.180.7	10,70	9,50	755.15.16.180.5	16,40	14,60
200	110	483	112	82	203	755.15.10.201.0	11,90	6,60	755.15.16.211.0	18,20	10,00
200	125	484	112	87	209	755.15.10.201.1	11,90	7,40	755.15.16.211.1	18,20	11,40
200	140	484	112	92	215	755.15.10.201.2	11,90	8,30	755.15.16.211.2	18,20	12,70
200	160	484	112	98	222	755.15.10.201.3	11,90	9,50	755.15.16.211.3	18,20	14,60
200	180	484	112	105	231	755.15.10.201.4	11,90	10,70	755.15.16.211.4	18,20	16,40
225	110	522	120	82	223	755.15.10.225.0	13,40	6,60	755.15.16.226.0	20,50	10,00
225	125	522	120	87	228	755.15.10.225.1	13,40	7,40	755.15.16.226.1	20,50	11,40
225	140	522	120	92	233	755.15.10.225.2	13,40	8,30	755.15.16.226.2	20,50	12,70
225	160	522	120	98	240	755.15.10.225.3	13,40	9,50	755.15.16.226.3	20,50	14,60
225	180	530	120	105	245	755.15.10.225.4	13,40	10,70	755.15.16.226.4	20,50	16,40
225	200	530	120	112	260	755.15.10.225.5	13,40	11,90	755.15.16.226.5	20,50	18,20
250	225	570	130	120	405	755.15.10.250.0	14,80	13,40	755.15.16.251.0	22,70	20,50
250	200	570	130	112	400	755.15.10.250.1	14,80	11,90	755.15.16.251.1	22,70	18,20
250	180	570	130	105	390	755.15.10.250.2	14,80	10,70	755.15.16.251.2	22,70	16,40
250	160	570	130	98	365	755.15.10.250.3	14,80	9,50	755.15.16.251.3	22,70	14,60
250	140	570	130	92	360	755.15.10.250.4	14,80	8,30	755.15.16.251.4	22,70	12,70
250	125	570	130	87	355	755.15.10.250.5	14,80	7,40	755.15.16.251.5	22,70	11,40
250	110	570	130	82	350	755.15.10.250.6	14,80	6,60	755.15.16.251.6	22,70	10,00
280	250	620	139	139	430	755.15.10.280.0	16,60	14,80	755.15.16.281.0	25,40	22,70
280	225	620	139	120	420	755.15.10.280.1	16,60	13,80	755.15.16.281.1	25,40	20,50
280	200	620	139	112	415	755.15.10.280.2	16,60	11,90	755.15.16.281.2	25,40	18,20
280	180	620	139	105	405	755.15.10.280.3	16,60	10,70	755.15.16.281.3	25,40	16,40
280	160	620	139	98	395	755.15.10.280.4	16,60	9,50	755.15.16.281.4	25,40	14,60
280	140	620	139	92	390	755.15.10.280.5	16,60	8,30	755.15.16.281.5	25,40	12,70
280	125	620	139	87	385	755.15.10.280.6	16,60	7,40	755.15.16.281.6	25,40	11,40
280	110	620	139	82	380	755.15.10.280.7	16,60	6,60	755.15.16.281.7	25,40	10,00
315	280	690	150	139	477	755.15.10.315.0	18,70	16,60	755.15.16.316.0	28,60	25,40
315	250	690	150	130	472	755.15.10.315.1	18,70	14,80	755.15.16.316.1	28,60	22,70
315	225	690	150	120	457	755.15.10.315.2	18,70	13,40	755.15.16.316.2	28,60	20,50
315	200	690	150	112	452	755.15.10.315.3	18,70	11,90	755.15.16.316.3	28,60	18,20
315	180	690	150	105	447	755.15.10.315.4	18,70	10,70	755.15.16.316.4	28,60	16,40
315	160	690	150	98	442	755.15.10.315.5	18,70	9,50	755.15.16.316.5	28,60	14,60
315	140	690	150	92	437	755.15.10.315.6	18,70	8,30	755.15.16.316.6	28,60	12,70
315	125	690	150	87	432	755.15.10.315.7	18,70	7,40	755.15.16.316.7	28,60	11,40
315	110	690	150	82	427	755.15.10.315.8	18,70	6,60	755.15.16.316.8	28,60	10,00

PE Pipe Fittings

Calculation Tables

PE 100 Inegal TEE

ISO 4427-3
 TS EN 12201-3 + A1
 DIN 16963

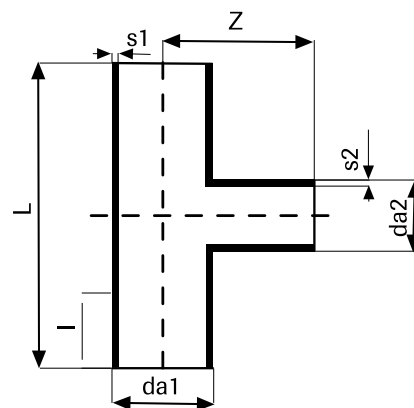

PE 100 Inegal TEE Calculation Table

da1 mm	da2 mm	L mm	l mm	z mm	SDR 26 - PN 6			SDR 17 - PN 10		
					Code	S1 mm	S2 mm	Code	S1 mm	S2 mm
90	63	355	125	170						
90	75	355	130	175						
110	50	355	125	180	755.15.06.110.1	6,60	3,00	755.15.10.110.1	10,0	4,60
110	63	355	125	180	755.15.06.110.2	6,60	3,80	755.15.10.110.2	10,0	5,80
110	75	320	130	185	755.15.06.110.3	6,60	4,50	755.15.10.110.3	10,0	6,80
110	90	380	130	185	755.15.06.110.4	6,60	5,40	755.15.10.110.4	10,0	8,20
125	63	350	125	188	755.15.06.125.1	7,40	3,80	755.15.10.125.1	11,4	5,80
125	75	375	130	193	755.15.06.125.2	7,40	4,50	755.15.10.125.2	11,4	6,80
125	90	375	130	193	755.15.06.125.3	7,40	5,40	755.15.10.125.3	11,4	8,20
125	110	395	130	193	755.15.06.125.4	7,40	6,60	755.15.10.125.4	11,4	10,0
140	50	390	125	195	755.15.06.140.5	8,30	3,00	755.15.10.140.5	12,7	4,60
140	63	390	125	195	755.15.06.140.6	8,30	3,80	755.15.10.140.6	12,7	5,80
140	75	390	130	200	755.15.06.140.7	8,30	4,50	755.15.10.140.7	12,7	6,80
140	90	390	130	200	755.15.06.140.1	8,30	5,40	755.15.10.140.1	12,7	8,20
140	110	410	130	200	755.15.06.140.2	8,30	6,60	755.15.10.140.2	12,7	10,0
140	125	410	130	200	755.15.06.140.3	8,30	7,40	755.15.10.140.3	12,7	11,4
160	63	380	125	205	755.15.06.160.7	9,50	3,80	755.15.10.160.7	14,6	5,80
160	75	390	130	210	755.15.06.160.8	9,50	4,50	755.15.10.160.8	14,6	6,80
160	90	405	130	210	755.15.06.160.3	9,50	5,40	755.15.10.160.3	14,6	8,20
160	110	425	130	210	755.15.06.160.4	9,50	6,60	755.15.10.160.4	14,6	10,0
160	125	440	130	210	755.15.06.160.5	9,50	7,40	755.15.10.160.5	14,6	11,4
160	140	455	140	220	755.15.06.160.6	9,50	8,30	755.15.10.160.6	14,6	12,7
180	50	410	125	215	755.15.06.180.7	10,7	3,00	755.15.10.180.7	16,4	4,60
180	63	410	125	215	755.15.06.180.8	10,7	3,80	755.15.10.180.8	16,4	5,80
180	75	410	130	220	755.15.06.180.9	10,7	4,50	755.15.10.180.9	16,4	6,80
180	90	435	130	220	755.15.06.180.2	10,7	5,40	755.15.10.180.2	16,4	8,20
180	110	456	130	220	755.15.06.180.3	10,7	6,60	755.15.10.180.3	16,4	10,0
180	125	468	130	220	755.15.06.180.4	10,7	7,40	755.15.10.180.4	16,4	11,4
180	140	490	140	230	755.15.06.180.5	10,7	8,30	755.15.10.180.5	16,4	12,7
180	160	510	140	230	755.15.06.180.6	10,7	9,50	755.15.10.180.6	16,4	14,6
200	50	410	125	225	755.15.06.200.7	11,9	3,00	755.15.10.200.7	18,2	4,60
200	63	410	125	225	755.15.06.200.8	11,9	3,80	755.15.10.200.8	18,2	5,80
200	75	410	130	230	755.15.06.200.9	11,9	4,50	755.15.10.200.9	18,2	6,80
200	90	438	130	230	755.15.06.200.1	11,9	5,40	755.15.10.200.1	18,2	8,20
200	110	455	130	230	755.15.06.200.2	11,9	6,60	755.15.10.200.2	18,2	10,0
200	125	470	130	230	755.15.06.200.3	11,9	7,40	755.15.10.200.3	18,2	11,4
200	140	480	140	240	755.15.06.200.4	11,9	8,30	755.15.10.200.4	18,2	12,7

PE 100 Inegal TEE Calculation Table

da1 mm	da2 mm	L mm	I mm	z mm	SDR 11 - PN 16			SDR 9 - PN 20		
					Code	S1 mm	S2 mm	Code	S1 mm	S2 mm
								755.15.20.90.1	12,3	8,60
								755.15.20.90.2	12,3	10,3
110	50	355	125	180	755.15.16.110.1	12,3	5,60	755.15.20.110.1	15,1	6,90
110	63	355	125	180	755.15.16.110.2	12,3	7,10	755.15.20.110.2	15,1	8,60
110	75	320	130	185	755.15.16.110.3	12,3	8,40	755.15.20.110.3	15,1	10,3
110	90	380	130	185	755.15.16.110.4	12,3	10,1	755.15.20.110.4	15,1	12,3
125	63	350	125	188	755.15.16.125.1	14,0	7,10	755.15.20.125.1	17,1	8,60
125	75	375	130	193	755.15.16.125.2	14,0	8,40	755.15.20.125.2	17,1	10,3
125	90	375	130	193	755.15.16.125.3	14,0	10,1	755.15.20.125.3	17,1	12,3
125	110	395	130	193	755.15.16.125.4	14,0	12,3	755.15.20.125.4	17,1	15,1
140	50	390	125	195	755.15.16.140.5	15,7	5,60	755.15.20.140.5	19,2	6,90
140	63	390	125	195	755.15.16.140.6	15,7	7,10	755.15.20.140.6	19,2	8,60
140	75	390	130	200	755.15.16.140.7	15,7	8,40	755.15.20.140.7	19,2	10,3
140	90	390	130	200	755.15.16.140.1	15,7	10,1	755.15.20.140.1	19,2	12,3
140	110	410	130	200	755.15.16.140.2	15,7	12,3	755.15.20.140.2	19,2	15,1
140	125	410	130	200	755.15.16.140.3	15,7	14,0	755.15.20.140.3	19,2	17,1
160	63	380	125	205	755.15.16.160.7	17,9	7,10	755.15.20.160.7	21,9	8,60
160	75	390	130	210	755.15.16.160.8	17,9	8,40	755.15.20.160.8	21,9	10,3
160	90	405	130	210	755.15.16.160.3	17,9	10,1	755.15.20.160.3	21,9	12,3
160	110	425	130	210	755.15.16.160.4	17,9	12,3	755.15.20.160.4	21,9	15,1
160	125	440	130	210	755.15.16.160.5	17,9	14,0	755.15.20.160.5	21,9	17,1
160	140	455	140	220	755.15.16.160.6	17,9	15,7	755.15.20.160.6	21,9	19,2
180	50	410	125	215	755.15.16.180.7	20,1	5,60	755.15.20.180.7	24,6	6,90
180	63	410	125	215	755.15.16.180.8	20,1	7,10	755.15.20.180.8	24,6	8,60
180	75	410	130	220	755.15.16.180.9	20,1	8,40	755.15.20.180.9	24,6	10,3
180	90	435	130	220	755.15.16.180.2	20,1	10,1	755.15.20.180.2	24,6	12,3
180	110	456	130	220	755.15.16.180.3	20,1	12,3	755.15.20.180.3	24,6	15,1
180	125	468	130	220	755.15.16.180.4	20,1	14,0	755.15.20.180.4	24,6	17,1
180	140	490	140	230	755.15.16.180.5	20,1	15,7	755.15.20.180.5	24,6	19,2
180	160	510	140	230	755.15.16.180.6	20,1	17,9	755.15.20.180.6	24,6	21,9
200	50	410	125	225	755.15.16.200.7	22,4	5,60	755.15.20.200.7	27,4	6,90
200	63	410	125	225	755.15.16.200.8	22,4	7,10	755.15.20.200.8	27,4	8,60
200	75	410	130	230	755.15.16.200.9	22,4	8,40	755.15.20.200.9	27,4	10,3
200	90	438	130	230	755.15.16.200.1	22,4	10,1	755.15.20.200.1	27,4	12,3
200	110	455	130	230	755.15.16.200.2	22,4	12,3	755.15.20.200.2	27,4	15,1
200	125	470	130	230	755.15.16.200.3	22,4	14,0	755.15.20.200.3	27,4	17,1
200	140	480	140	240	755.15.16.200.4	22,4	15,7	755.15.20.200.4	27,4	19,2

PE 100 Inegal TEE Calculation Table

da1 mm	da2 mm	L mm	I mm	z mm	SDR 26 - PN 6			SDR 17 - PN 10		
					Code	S1 mm	S2 mm	Code	S1 mm	S2 mm
200	160	500	140	240	755.15.06.200.5	11,9	9,50	755.15.10.200.5	18,2	14,6
200	180	520	160	260	755.15.06.200.6	11,9	10,7	755.15.10.200.6	18,2	16,4
225	50	405	125	237,5	755.15.06.225.8	13,4	3,00	755.15.10.225.8	20,5	4,60
225	63	420	125	237,5	755.15.06.225.9	13,4	3,80	755.15.10.225.9	20,5	5,80
225	75	430	130	242,5	755.15.06.225.10	13,4	4,50	755.15.10.225.10	20,5	6,80
225	90	440	130	242,5	755.15.06.225.1	13,4	5,40	755.15.10.225.1	20,5	8,20
225	110	450	130	242,5	755.15.06.225.2	13,4	6,60	755.15.10.225.2	20,5	10,0
225	125	468	130	242,5	755.15.06.225.3	13,4	7,40	755.15.10.225.3	20,5	11,4
225	140	505	140	252,5	755.15.06.225.4	13,4	8,30	755.15.10.225.4	20,5	12,7
225	160	505	140	252,5	755.15.06.225.5	13,4	9,50	755.15.10.225.5	20,5	14,6
225	180	610	160	272,5	755.15.06.225.6	13,4	10,7	755.15.10.225.6	20,5	16,4
225	200	630	160	272,5	755.15.06.225.7	13,4	11,9	755.15.10.225.7	20,5	18,2
250	50	440	125	250	755.15.06.250.9	9,10	3,00	755.15.10.250.9	14,8	4,60
250	63	455	125	250	755.15.06.250.10	9,10	3,80	755.15.10.250.10	14,8	5,80
250	75	455	130	255	755.15.06.250.11	9,10	4,50	755.15.10.250.11	14,8	6,80
250	90	455	130	255	755.15.06.250.1	9,10	5,40	755.15.10.250.1	14,8	8,20
250	110	475	130	255	755.15.06.250.2	9,10	6,60	755.15.10.250.2	14,8	10,0
250	125	490	130	255	755.15.06.250.3	9,10	7,40	755.15.10.250.3	14,8	11,4
250	140	490	140	265	755.15.06.250.4	9,10	8,30	755.15.10.250.4	14,8	12,7
250	160	525	140	265	755.15.06.250.5	9,10	9,50	755.15.10.250.5	14,8	14,6
250	180	525	160	285	755.15.06.250.6	9,10	10,7	755.15.10.250.6	14,8	16,4
250	200	525	160	285	755.15.06.250.7	9,10	11,9	755.15.10.250.7	14,8	18,2
250	225	530	170	295	755.15.06.250.8	9,10	13,4	755.15.10.250.8	14,8	20,5
280	50	350	125	265	755.15.06.280.9	10,2	3,00	755.15.10.280.9	16,6	4,60
280	63	365	125	265	755.15.06.280.10	10,2	3,80	755.15.10.280.10	16,6	5,80
280	75	495	130	270	755.15.06.280.11	10,2	4,50	755.15.10.280.11	16,6	6,80
280	90	410	130	270	755.15.06.280.12	10,2	5,40	755.15.10.280.12	16,6	8,20
280	110	440	130	270	755.15.06.280.1	10,2	6,60	755.15.10.280.1	16,6	10,0
280	125	460	130	270	755.15.06.280.2	10,2	7,40	755.15.10.280.2	16,6	11,4
280	140	480	140	280	755.15.06.280.3	10,2	8,30	755.15.10.280.3	16,6	12,7
280	160	495	140	280	755.15.06.280.4	10,2	9,50	755.15.10.280.4	16,6	14,6
280	180	505	160	300	755.15.06.280.5	10,2	10,7	755.15.10.280.5	16,6	16,4
280	200	515	160	300	755.15.06.280.6	10,2	11,9	755.15.10.280.6	16,6	18,2
280	225	535	170	310	755.15.06.280.7	10,2	13,4	755.15.10.280.7	16,6	20,5
280	250	560	170	310	755.15.06.280.8	10,2	14,8	755.15.10.280.8	16,6	22,7
315	50	400	125	282,5	755.15.06.315.9	11,4	3,00	755.15.10.315.9	18,7	4,60
315	63	410	125	282,5	755.15.06.315.10	11,4	3,80	755.15.10.315.10	18,7	5,80
315	75	430	130	287,5	755.15.06.315.11	11,4	4,50	755.15.10.315.11	18,7	6,80
315	90	445	130	287,5	755.15.06.315.12	11,4	5,40	755.15.10.315.12	18,7	8,20
315	110	465	130	287,5	755.15.06.315.0	11,4	6,60	755.15.10.315.0	18,7	10,0
315	125	490	130	287,5	755.15.06.315.1	11,4	7,40	755.15.10.315.1	18,7	11,4
315	140	500	140	297,5	755.15.06.315.2	11,4	8,30	755.15.10.315.2	18,7	12,7
315	160	510	140	297,5	755.15.06.315.3	11,4	9,50	755.15.10.315.3	18,7	14,6
315	180	535	160	317,5	755.15.06.315.4	11,4	10,7	755.15.10.315.4	18,7	16,4
315	200	565	160	317,5	755.15.06.315.5	11,4	11,9	755.15.10.315.5	18,7	18,2
315	225	585	170	327,5	755.15.06.315.6	11,4	13,4	755.15.10.315.6	18,7	20,5
315	250	605	170	327,5	755.15.06.315.7	11,4	14,8	755.15.10.315.7	18,7	22,7

PE 100 Inegal TEE Calculation Table

da1 mm	da2 mm	L mm	I mm	z mm	SDR 11 - PN 16			SDR 9 - PN 20		
					Code	S1 mm	S2 mm	Code	S1 mm	S2 mm
200	160	500	140	240	755.15.16.200.5	22,4	17,9	755.15.20.200.5	27,4	21,9
200	180	520	160	260	755.15.16.200.6	22,4	20,1	755.15.20.200.6	27,4	24,6
225	50	405	125	237,5	755.15.16.225.8	25,2	5,60	755.15.20.225.8	30,8	6,90
225	63	420	125	237,5	755.15.16.225.9	25,2	7,10	755.15.20.225.9	30,8	8,60
225	75	430	130	242,5	755.15.16.225.10	25,2	8,40	755.15.20.225.10	30,8	10,3
225	90	440	130	242,5	755.15.16.225.1	25,2	10,1	755.15.20.225.1	30,8	12,3
225	110	450	130	242,5	755.15.16.225.2	25,2	12,3	755.15.20.225.2	30,8	15,1
225	125	468	130	242,5	755.15.16.225.3	25,2	14,0	755.15.20.225.3	30,8	17,1
225	140	505	140	252,5	755.15.16.225.4	25,2	15,7	755.15.20.225.4	30,8	19,2
225	160	505	140	252,5	755.15.16.225.5	25,2	17,9	755.15.20.225.5	30,8	21,9
225	180	610	160	272,5	755.15.16.225.6	25,2	20,1	755.15.20.225.6	30,8	24,6
225	200	630	160	272,5	755.15.16.225.7	25,2	22,4	755.15.20.225.7	30,8	27,4
250	50	440	125	250	755.15.16.250.9	22,7	5,60	755.15.20.250.9	27,9	6,90
250	63	455	125	250	755.15.16.250.10	22,7	7,10	755.15.20.250.10	27,9	8,60
250	75	455	130	255	755.15.16.250.11	22,7	8,40	755.15.20.250.11	27,9	10,3
250	90	455	130	255	755.15.16.250.1	22,7	10,1	755.15.20.250.1	27,9	12,3
250	110	475	130	255	755.15.16.250.2	22,7	12,3	755.15.20.250.2	27,9	15,1
250	125	490	130	255	755.15.16.250.3	22,7	14,0	755.15.20.250.3	27,9	17,1
250	140	490	140	265	755.15.16.250.4	22,7	15,7	755.15.20.250.4	27,9	19,2
250	160	525	140	265	755.15.16.250.5	22,7	17,9	755.15.20.250.5	27,9	21,9
250	180	525	160	285	755.15.16.250.6	22,7	20,1	755.15.20.250.6	27,9	24,6
250	200	525	160	285	755.15.16.250.7	22,7	22,4	755.15.20.250.7	27,9	27,4
250	225	530	170	295	755.15.16.250.8	22,7	25,2	755.15.20.250.8	27,9	30,8
280	50	350	125	265	755.15.16.280.9	25,4	5,60	755.15.20.280.9	31,3	6,90
280	63	365	125	265	755.15.16.280.10	25,4	7,10	755.15.20.280.10	31,3	8,60
280	75	495	130	270	755.15.16.280.11	25,4	8,40	755.15.20.280.11	31,3	10,3
280	90	410	130	270	755.15.16.280.12	25,4	10,1	755.15.20.280.12	31,3	12,3
280	110	440	130	270	755.15.16.280.1	25,4	12,3	755.15.20.280.1	31,3	15,1
280	125	460	130	270	755.15.16.280.2	25,4	14,0	755.15.20.280.2	31,3	17,1
280	140	480	140	280	755.15.16.280.3	25,4	15,7	755.15.20.280.3	31,3	19,2
280	160	495	140	280	755.15.16.280.4	25,4	17,9	755.15.20.280.4	31,3	21,9
280	180	505	160	300	755.15.16.280.5	25,4	20,1	755.15.20.280.5	31,3	24,6
280	200	515	160	300	755.15.16.280.6	25,4	22,4	755.15.20.280.6	31,3	27,4
280	225	535	170	310	755.15.16.280.7	25,4	25,2	755.15.20.280.7	31,3	30,8
280	250	560	170	310	755.15.16.280.8	25,4	27,9	755.15.20.280.8	31,3	34,2
315	50	400	125	282,5	755.15.16.315.9	28,6	5,60	755.15.20.315.9	35,2	6,90
315	63	410	125	282,5	755.15.16.315.10	28,6	7,10	755.15.20.315.10	35,2	8,60
315	75	430	130	287,5	755.15.16.315.11	28,6	8,40	755.15.20.315.11	35,2	10,3
315	90	445	130	287,5	755.15.16.315.12	28,6	10,1	755.15.20.315.12	35,2	12,3
315	110	465	130	287,5	755.15.16.315.0	28,6	12,3	755.15.20.315.0	35,2	15,1
315	125	490	130	287,5	755.15.16.315.1	28,6	14,0	755.15.20.315.1	35,2	17,1
315	140	500	140	297,5	755.15.16.315.2	28,6	15,7	755.15.20.315.2	35,2	19,2
315	160	510	140	297,5	755.15.16.315.3	28,6	17,9	755.15.20.315.3	35,2	21,9
315	180	535	160	317,5	755.15.16.315.4	28,6	20,1	755.15.20.315.4	35,2	24,6
315	200	565	160	317,5	755.15.16.315.5	28,6	22,4	755.15.20.315.5	35,2	27,4
315	225	585	170	327,5	755.15.16.315.6	28,6	25,2	755.15.20.315.6	35,2	30,8
315	250	605	170	327,5	755.15.16.315.7	28,6	27,9	755.15.20.315.7	35,2	34,2

PE 100 Inegal TEE Calculation Table

da1 mm	da2 mm	L mm	l mm	z mm	SDR 26 - PN 6			SDR 17 - PN 10		
					Code	S1 mm	S2 mm	Code	S1 mm	S2 mm
315	280	640	180	337,5	755.15.06.315.8	11,4	16,6	755.15.10.315.8	18,7	25,4
355	50	410	125	302,5	755.15.06.355.11	12,9	3,00	755.15.10.355.11	21,1	4,60
355	63	420	125	302,5	755.15.06.355.12	12,9	3,80	755.15.10.355.12	21,1	5,80
355	75	440	130	307,5	755.15.06.355.13	12,9	4,50	755.15.10.355.13	21,1	6,80
355	90	450	130	307,5	755.15.06.355.14	12,9	5,40	755.15.10.355.14	21,1	8,20
355	110	470	130	307,5	755.15.06.355.1	12,9	6,60	755.15.10.355.1	21,1	10,0
355	125	485	130	307,5	755.15.06.355.2	12,9	7,40	755.15.10.355.2	21,1	11,4
355	140	500	140	317,5	755.15.06.355.3	12,9	8,30	755.15.10.355.3	21,1	12,7
355	160	520	140	317,5	755.15.06.355.4	12,9	9,50	755.15.10.355.4	21,1	14,6
355	180	540	160	337,5	755.15.06.355.5	12,9	10,7	755.15.10.355.5	21,1	16,4
355	200	560	160	337,5	755.15.06.355.6	12,9	11,9	755.15.10.355.6	21,1	18,2
355	225	585	170	347,5	755.15.06.355.7	12,9	13,4	755.15.10.355.7	21,1	20,5
355	250	610	170	347,5	755.15.06.355.8	12,9	14,8	755.15.10.355.8	21,1	22,7
355	280	640	180	357,5	755.15.06.355.9	12,9	16,6	755.15.10.355.9	21,1	25,4
355	315	675	200	377,5	755.15.06.355.10	12,9	18,7	755.15.10.355.10	21,1	28,6
400	50	470	125	325	755.15.06.400.12	14,5	3,00	755.15.10.400.12	23,7	4,60
400	63	480	125	325	755.15.06.400.13	14,5	3,80	755.15.10.400.13	23,7	5,80
400	75	500	130	330	755.15.06.400.14	14,5	4,50	755.15.10.400.14	23,7	6,80
400	90	510	130	330	755.15.06.400.15	14,5	5,40	755.15.10.400.15	23,7	8,20
400	110	525	130	330	755.15.06.400.1	14,5	6,60	755.15.10.400.1	23,7	10,0
400	125	540	130	330	755.15.06.400.2	14,5	7,40	755.15.10.400.2	23,7	11,4
400	140	560	140	340	755.15.06.400.3	14,5	8,30	755.15.10.400.3	23,7	12,7
400	160	590	140	340	755.15.06.400.4	14,5	9,50	755.15.10.400.4	23,7	14,6
400	180	600	160	360	755.15.06.400.5	14,5	10,7	755.15.10.400.5	23,7	16,4
400	200	620	160	360	755.15.06.400.6	14,5	11,9	755.15.10.400.6	23,7	18,2
400	225	640	170	370	755.15.06.400.7	14,5	13,4	755.15.10.400.7	23,7	20,5
400	250	665	170	370	755.15.06.400.8	14,5	14,8	755.15.10.400.8	23,7	22,7
400	280	695	180	380	755.15.06.400.9	14,5	16,6	755.15.10.400.9	23,7	25,4
400	315	730	200	400	755.15.06.400.10	14,5	18,7	755.15.10.400.10	23,7	28,6
400	355	770	200	400	755.15.06.400.11	14,5	21,1	755.15.10.400.11	23,7	32,2
450	50	460	130	355	755.15.06.450.13	16,3	3,00	755.15.10.450.13	26,7	4,60
450	63	470	130	355	755.15.06.450.14	16,3	3,80	755.15.10.450.14	26,7	5,80
450	75	490	140	365	755.15.06.450.15	16,3	4,50	755.15.10.450.15	26,7	6,80
450	90	505	140	365	755.15.06.450.16	16,3	5,40	755.15.10.450.16	26,7	8,20
450	110	525	150	375	755.15.06.450.1	16,3	6,60	755.15.10.450.1	26,7	10,0
450	125	540	150	375	755.15.06.450.2	16,3	7,40	755.15.10.450.2	26,7	11,4
450	140	555	150	375	755.15.06.450.3	16,3	8,30	755.15.10.450.3	26,7	12,7
450	160	575	150	375	755.15.06.450.4	16,3	9,50	755.15.10.450.4	26,7	14,6
450	180	595	180	405	755.15.06.450.5	16,3	10,7	755.15.10.450.5	26,7	16,4
450	200	615	180	405	755.15.06.450.6	16,3	11,9	755.15.10.450.6	26,7	18,2
450	225	640	190	415	755.15.06.450.7	16,3	13,4	755.15.10.450.7	26,7	20,5
450	250	665	200	425	755.15.06.450.8	16,3	14,8	755.15.10.450.8	26,7	22,7
450	280	695	200	425	755.15.06.450.9	16,3	16,6	755.15.10.450.9	26,7	25,4
450	315	730	225	450	755.15.06.450.10	16,3	18,7	755.15.10.450.10	26,7	28,6
450	355	770	225	450	755.15.06.450.11	16,3	21,1	755.15.10.450.11	26,7	32,2
450	400	815	200	425	755.15.06.450.12	16,3	23,7	755.15.10.450.12	26,7	36,3
500	50	500	130	380	755.15.06.500.14	18,1	3,00	755.15.10.500.14	29,7	4,60

PE 100 Inegal TEE Calculation Table

da1 mm	da2 mm	L mm	I mm	z mm	SDR 11 - PN 16			SDR 9 - PN 20		
					Code	S1 mm	S2 mm	Code	S1 mm	S2 mm
315	280	640	180	337,5	755.15.16.315.8	28,6	31,3	755.15.20.315.8	35,2	38,3
355	50	410	125	302,5	755.15.16.355.11	32,2	5,60	755.15.20.355.11	39,7	6,90
355	63	420	125	302,5	755.15.16.355.12	32,2	7,10	755.15.20.355.12	39,7	8,60
355	75	440	130	307,5	755.15.16.355.13	32,2	8,40	755.15.20.355.13	39,7	10,3
355	90	450	130	307,5	755.15.16.355.14	32,2	10,1	755.15.20.355.14	39,7	12,3
355	110	470	130	307,5	755.15.16.355.1	32,2	12,3	755.15.20.355.1	39,7	15,1
355	125	485	130	307,5	755.15.16.355.2	32,2	14,0	755.15.20.355.2	39,7	17,1
355	140	500	140	317,5	755.15.16.355.3	32,2	15,7	755.15.20.355.3	39,7	19,2
355	160	520	140	317,5	755.15.16.355.4	32,2	17,9	755.15.20.355.4	39,7	21,9
355	180	540	160	337,5	755.15.16.355.5	32,2	20,1	755.15.20.355.5	39,7	24,6
355	200	560	160	337,5	755.15.16.355.6	32,2	22,4	755.15.20.355.6	39,7	27,4
355	225	585	170	347,5	755.15.16.355.7	32,2	25,2	755.15.20.355.7	39,7	30,8
355	250	610	170	347,5	755.15.16.355.8	32,2	27,9	755.15.20.355.8	39,7	34,2
355	280	640	180	357,5	755.15.16.355.9	32,2	31,3	755.15.20.355.9	39,7	38,3
355	315	675	200	377,5	755.15.16.355.10	32,2	35,2	755.15.20.355.10	39,7	43,1
400	50	470	125	325	755.15.16.400.12	36,3	5,60	755.15.20.400.12	44,7	6,90
400	63	480	125	325	755.15.16.400.13	36,3	7,10	755.15.20.400.13	44,7	8,60
400	75	500	130	330	755.15.16.400.14	36,3	8,40	755.15.20.400.14	44,7	10,3
400	90	510	130	330	755.15.16.400.15	36,3	10,1	755.15.20.400.15	44,7	12,3
400	110	525	130	330	755.15.16.400.1	36,3	12,3	755.15.20.400.1	44,7	15,1
400	125	540	130	330	755.15.16.400.2	36,3	14,0	755.15.20.400.2	44,7	17,1
400	140	560	140	340	755.15.16.400.3	36,3	15,7	755.15.20.400.3	44,7	19,2
400	160	590	140	340	755.15.16.400.4	36,3	17,9	755.15.20.400.4	44,7	21,9
400	180	600	160	360	755.15.16.400.5	36,3	20,1	755.15.20.400.5	44,7	24,6
400	200	620	160	360	755.15.16.400.6	36,3	22,4	755.15.20.400.6	44,7	27,4
400	225	640	170	370	755.15.16.400.7	36,3	25,2	755.15.20.400.7	44,7	30,8
400	250	665	170	370	755.15.16.400.8	36,3	27,9	755.15.20.400.8	44,7	34,2
400	280	695	180	380	755.15.16.400.9	36,3	31,3	755.15.20.400.9	44,7	38,3
400	315	730	200	400	755.15.16.400.10	36,3	35,2	755.15.20.400.10	44,7	43,1
400	355	770	200	400	755.15.16.400.11	36,3	39,7	755.15.20.400.11	44,7	48,5
450	50	460	130	355	755.15.16.450.13	40,9	5,60	755.15.20.450.13	50,3	6,90
450	63	470	130	355	755.15.16.450.14	40,9	7,10	755.15.20.450.14	50,3	8,60
450	75	490	140	365	755.15.16.450.15	40,9	8,40	755.15.20.450.15	50,3	10,3
450	90	505	140	365	755.15.16.450.16	40,9	10,1	755.15.20.450.16	50,3	12,3
450	110	525	150	375	755.15.16.450.1	40,9	12,3	755.15.20.450.1	50,3	15,1
450	125	540	150	375	755.15.16.450.2	40,9	14,0	755.15.20.450.2	50,3	17,1
450	140	555	150	375	755.15.16.450.3	40,9	15,7	755.15.20.450.3	50,3	19,2
450	160	575	150	375	755.15.16.450.4	40,9	17,9	755.15.20.450.4	50,3	21,9
450	180	595	180	405	755.15.16.450.5	40,9	20,1	755.15.20.450.5	50,3	24,6
450	200	615	180	405	755.15.16.450.6	40,9	22,4	755.15.20.450.6	50,3	27,4
450	225	640	190	415	755.15.16.450.7	40,9	25,2	755.15.20.450.7	50,3	30,8
450	250	665	200	425	755.15.16.450.8	40,9	27,9	755.15.20.450.8	50,3	34,2
450	280	695	200	425	755.15.16.450.9	40,9	31,3	755.15.20.450.9	50,3	38,3
450	315	730	225	450	755.15.16.450.10	40,9	35,2	755.15.20.450.10	50,3	43,1
450	355	770	225	450	755.15.16.450.11	40,9	39,7	755.15.20.450.11	50,3	48,5
450	400	815	200	425	755.15.16.450.12	40,9	44,7	755.15.20.450.12	50,3	54,7
500	50	500	130	380	755.15.16.500.14	45,4	5,60	755.15.20.500.14	55,8	6,90

PE 100 Inegal TEE Calculation Table

da1 mm	da2 mm	L mm	l mm	z mm	SDR 26 - PN 6			SDR 17 - PN 10		
					Code	S1 mm	S2 mm	Code	S1 mm	S2 mm
500	63	510	130	380	755.15.06.500.15	18,1	3,80	755.15.10.500.15	29,7	5,80
500	75	540	140	390	755.15.06.500.16	18,1	4,50	755.15.10.500.16	29,7	6,80
500	90	550	140	390	755.15.06.500.17	18,1	5,40	755.15.10.500.17	29,7	8,20
500	110	565	150	400	755.15.06.500.1	18,1	6,60	755.15.10.500.1	29,7	10,0
500	125	580	150	400	755.15.06.500.2	18,1	7,40	755.15.10.500.2	29,7	11,4
500	140	595	150	400	755.15.06.500.3	18,1	8,30	755.15.10.500.3	29,7	12,7
500	160	615	150	400	755.15.06.500.4	18,1	9,50	755.15.10.500.4	29,7	14,6
500	180	635	180	430	755.15.06.500.5	18,1	10,7	755.15.10.500.5	29,7	16,4
500	200	655	180	430	755.15.06.500.6	18,1	11,9	755.15.10.500.6	29,7	18,2
500	225	680	190	440	755.15.06.500.7	18,1	13,4	755.15.10.500.7	29,7	20,5
500	250	705	200	450	755.15.06.500.8	18,1	14,8	755.15.10.500.8	29,7	22,7
500	280	735	200	450	755.15.06.500.9	18,1	16,6	755.15.10.500.9	29,7	25,4
500	315	770	225	475	755.15.06.500.10	18,1	18,7	755.15.10.500.10	29,7	28,6
500	355	810	225	475	755.15.06.500.11	18,1	21,1	755.15.10.500.11	29,7	32,2
500	400	855	200	450	755.15.06.500.12	18,1	23,7	755.15.10.500.12	29,7	36,3
560	50	535	130	410	755.15.06.560.15	20,3	3,00	755.15.10.560.15	33,2	4,60
560	63	543	130	410	755.15.06.560.16	20,3	3,80	755.15.10.560.16	33,2	5,80
560	75	555	140	420	755.15.06.560.17	20,3	4,50	755.15.10.560.17	33,2	6,80
560	90	580	140	420	755.15.06.560.18	20,3	5,40	755.15.10.560.18	33,2	8,20
560	110	600	150	430	755.15.06.560.1	20,3	6,60	755.15.10.560.1	33,2	10,0
560	125	620	150	430	755.15.06.560.2	20,3	7,40	755.15.10.560.2	33,2	11,4
560	140	625	150	430	755.15.06.560.3	20,3	8,30	755.15.10.560.3	33,2	12,7
560	160	650	150	430	755.15.06.560.4	20,3	9,50	755.15.10.560.4	33,2	14,6
560	180	670	180	460	755.15.06.560.5	20,3	10,7	755.15.10.560.5	33,2	16,4
560	200	690	180	460	755.15.06.560.6	20,3	11,9	755.15.10.560.6	33,2	18,2
560	225	715	190	470	755.15.06.560.7	20,3	13,4	755.15.10.560.7	33,2	20,5
560	250	740	200	480	755.15.06.560.8	20,3	14,8	755.15.10.560.8	33,2	22,7
560	280	765	200	480	755.15.06.560.9	20,3	16,6	755.15.10.560.9	33,2	25,4
560	315	800	225	505	755.15.06.560.10	20,3	18,7	755.15.10.560.10	33,2	28,6
560	355	835	225	505	755.15.06.560.11	20,3	21,1	755.15.10.560.11	33,2	32,2
560	400	885	200	480	755.15.06.560.12	20,3	23,7	755.15.10.560.12	33,2	36,3
630	50	615	130	445	755.15.06.630.16	22,8	3,00	755.15.10.630.16	37,4	4,60
630	63	625	130	445	755.15.06.630.17	22,8	3,80	755.15.10.630.17	37,4	5,80
630	75	640	140	455	755.15.06.630.18	22,8	4,50	755.15.10.630.18	37,4	6,80
630	90	670	140	455	755.15.06.630.19	22,8	5,40	755.15.10.630.19	37,4	8,20
630	110	690	150	465	755.15.06.630.1	22,8	6,60	755.15.10.630.1	37,4	10,0
630	125	705	150	465	755.15.06.630.2	22,8	7,40	755.15.10.630.2	37,4	11,4
630	140	715	150	465	755.15.06.630.3	22,8	8,30	755.15.10.630.3	37,4	12,7
630	160	730	150	465	755.15.06.630.4	22,8	9,50	755.15.10.630.4	37,4	14,6
630	180	750	180	495	755.15.06.630.5	22,8	10,7	755.15.10.630.5	37,4	16,4
630	200	770	180	495	755.15.06.630.6	22,8	11,9	755.15.10.630.6	37,4	18,2
630	225	795	190	505	755.15.06.630.7	22,8	13,4	755.15.10.630.7	37,4	20,5
630	250	820	200	515	755.15.06.630.8	22,8	14,8	755.15.10.630.8	37,4	22,7
630	280	850	200	515	755.15.06.630.9	22,8	16,6	755.15.10.630.9	37,4	25,4
630	315	885	225	540	755.15.06.630.10	22,8	18,7	755.15.10.630.10	37,4	28,6
630	355	925	225	540	755.15.06.630.11	22,8	21,1	755.15.10.630.11	37,4	32,2

PE 100 Inegal TEE Calculation Table

da1 mm	da2 mm	L mm	I mm	z mm	SDR 11 - PN 16			SDR 9 - PN 20		
					Code	S1 mm	S2 mm	Code	S1 mm	S2 mm
500	63	510	130	380	755.15.16.500.15	45,4	7,10	755.15.20.500.15	55,8	8,60
500	75	540	140	390	755.15.16.500.16	45,4	8,40	755.15.20.500.16	55,8	10,3
500	90	550	140	390	755.15.16.500.17	45,4	10,1	755.15.20.500.17	55,8	12,3
500	110	565	150	400	755.15.16.500.1	45,4	12,3	755.15.20.500.1	55,8	15,1
500	125	580	150	400	755.15.16.500.2	45,4	14,0	755.15.20.500.2	55,8	17,1
500	140	595	150	400	755.15.16.500.3	45,4	15,7	755.15.20.500.3	55,8	19,2
500	160	615	150	400	755.15.16.500.4	45,4	17,9	755.15.20.500.4	55,8	21,9
500	180	635	180	430	755.15.16.500.5	45,4	20,1	755.15.20.500.5	55,8	24,6
500	200	655	180	430	755.15.16.500.6	45,4	22,4	755.15.20.500.6	55,8	27,4
500	225	680	190	440	755.15.16.500.7	45,4	25,2	755.15.20.500.7	55,8	30,8
500	250	705	200	450	755.15.16.500.8	45,4	27,9	755.15.20.500.8	55,8	34,2
500	280	735	200	450	755.15.16.500.9	45,4	31,3	755.15.20.500.9	55,8	38,3
500	315	770	225	475	755.15.16.500.10	45,4	35,2	755.15.20.500.10	55,8	43,1
500	355	810	225	475	755.15.16.500.11	45,4	39,7	755.15.20.500.11	55,8	48,5
500	400	855	200	450	755.15.16.500.12	45,4	44,7	755.15.20.500.12	55,8	54,7
560	50	535	130	410	755.15.16.560.15	50,8	5,60	755.15.20.560.15	62,5	6,90
560	63	543	130	410	755.15.16.560.16	50,8	7,10	755.15.20.560.16	62,5	8,60
560	75	555	140	420	755.15.16.560.17	50,8	8,40	755.15.20.560.17	62,5	10,3
560	90	580	140	420	755.15.16.560.18	50,8	10,1	755.15.20.560.18	62,5	12,3
560	110	600	150	430	755.15.16.560.1	50,8	12,3	755.15.20.560.1	62,5	15,1
560	125	620	150	430	755.15.16.560.2	50,8	14,0	755.15.20.560.2	62,5	17,1
560	140	625	150	430	755.15.16.560.3	50,8	15,7	755.15.20.560.3	62,5	19,2
560	160	650	150	430	755.15.16.560.4	50,8	17,9	755.15.20.560.4	62,5	21,9
560	180	670	180	460	755.15.16.560.5	50,8	20,1	755.15.20.560.5	62,5	24,6
560	200	690	180	460	755.15.16.560.6	50,8	22,4	755.15.20.560.6	62,5	27,4
560	225	715	190	470	755.15.16.560.7	50,8	25,2	755.15.20.560.7	62,5	30,8
560	250	740	200	480	755.15.16.560.8	50,8	27,9	755.15.20.560.8	62,5	34,2
560	280	765	200	480	755.15.16.560.9	50,8	31,3	755.15.20.560.9	62,5	38,3
560	315	800	225	505	755.15.16.560.10	50,8	35,2	755.15.20.560.10	62,5	43,1
560	355	835	225	505	755.15.16.560.11	50,8	39,7	755.15.20.560.11	62,5	48,5
560	400	885	200	480	755.15.16.560.12	50,8	44,7	755.15.20.560.12	62,5	54,7
630	50	615	130	445	755.15.16.630.16	57,2	5,60			
630	63	625	130	445	755.15.16.630.17	57,2	7,10			
630	75	640	140	455	755.15.16.630.18	57,2	8,40			
630	90	670	140	455	755.15.16.630.19	57,2	10,1			
630	110	690	150	465	755.15.16.630.1	57,2	12,3			
630	125	705	150	465	755.15.16.630.2	57,2	14,0			
630	140	715	150	465	755.15.16.630.3	57,2	15,7			
630	160	730	150	465	755.15.16.630.4	57,2	17,9			
630	180	750	180	495	755.15.16.630.5	57,2	20,1			
630	200	770	180	495	755.15.16.630.6	57,2	22,4			
630	225	795	190	505	755.15.16.630.7	57,2	25,2			
630	250	820	200	515	755.15.16.630.8	57,2	27,9			
630	280	850	200	515	755.15.16.630.9	57,2	31,3			
630	315	885	225	540	755.15.16.630.10	57,2	35,2			
630	355	925	225	540	755.15.16.630.11	57,2	39,7			

PE 100 Inegal TEE Calculation Table

da1 mm	da2 mm	L mm	I mm	z mm	SDR 26 - PN 16			SDR 17 - PN 10			SDR 11 - PN 16		
					Code	S1 mm	S2 mm	Code	S1 mm	S2 mm	Code	S1 mm	S2 mm
630	400	970	200	515	755.15.06.630.12	22,8	23,7	755.15.10.630.12	37,4	36,3	755.15.16.630.12	57,2	44,7
710	90	600	140	495	755.15.06.710.17	25,7	5,40	755.15.10.710.17	42,1	8,2	755.15.16.710.17	64,5	10,1
710	110	680	150	505	755.15.06.710.1	25,7	6,60	755.15.10.710.1	42,1	10,0	755.15.16.710.1	64,5	12,3
710	125	695	150	505	755.15.06.710.2	25,7	7,40	755.15.10.710.2	42,1	11,4	755.15.16.710.2	64,5	14,0
710	140	710	150	505	755.15.06.710.3	25,7	8,30	755.15.10.710.3	42,1	12,7	755.15.16.710.3	64,5	15,7
710	160	730	150	505	755.15.06.710.4	25,7	9,50	755.15.10.710.4	42,1	14,6	755.15.16.710.4	64,5	17,9
710	180	750	180	535	755.15.06.710.5	25,7	10,7	755.15.10.710.5	42,1	16,4	755.15.16.710.5	64,5	20,1
710	200	770	180	535	755.15.06.710.6	25,7	11,9	755.15.10.710.6	42,1	18,2	755.15.16.710.6	64,5	22,4
710	225	795	190	545	755.15.06.710.7	25,7	13,4	755.15.10.710.7	42,1	14,6	755.15.16.710.7	64,5	25,2
710	250	820	200	555	755.15.06.710.8	25,7	14,8	755.15.10.710.8	42,1	16,4	755.15.16.710.8	64,5	27,9
710	280	850	200	555	755.15.06.710.9	25,7	16,6	755.15.10.710.9	42,1	18,2	755.15.16.710.9	64,5	31,3
710	315	895	225	580	755.15.06.710.10	25,7	18,7	755.15.10.710.10	42,1	20,5	755.15.16.710.10	64,5	35,2
710	355	925	225	580	755.15.06.710.11	25,7	21,1	755.15.10.710.11	42,1	22,7	755.15.16.710.11	64,5	39,7
710	400	970	200	555	755.15.06.710.12	25,7	23,7	755.15.10.710.12	42,1	25,4	755.15.16.710.12	64,5	44,7
800	90	700	140	540	755.15.06.800.18	29,0	5,40	755.15.10.800.18	47,4	28,6	755.15.16.800.18	72,7	10,1
800	110	720	150	550	755.15.06.800.1	29,0	6,60	755.15.10.800.1	47,4	32,2	755.15.16.800.1	72,7	12,3
800	125	735	150	550	755.15.06.800.2	29,0	7,40	755.15.10.800.2	47,4	36,3	755.15.16.800.2	72,7	14,0
800	140	750	150	550	755.15.06.800.3	29,0	8,30	755.15.10.800.3	47,4	40,9	755.15.16.800.3	72,7	15,7
800	160	770	150	550	755.15.06.800.4	29,0	9,50	755.15.10.800.4	47,4	46,0	755.15.16.800.4	72,7	17,9
800	180	790	180	580	755.15.06.800.5	29,0	10,7	755.15.10.800.5	47,4	58,0	755.15.16.800.5	72,7	20,1
800	200	810	180	580	755.15.06.800.6	29,0	11,9	755.15.10.800.6	47,4	68,0	755.15.16.800.6	72,7	22,4
800	225	835	190	590	755.15.06.800.7	29,0	13,4	755.15.10.800.7	47,4	82,0	755.15.16.800.7	72,7	25,2
800	250	860	200	600	755.15.06.800.8	29,0	14,8	755.15.10.800.8	47,4	10,0	755.15.16.800.8	72,7	27,9
800	280	890	200	600	755.15.06.800.9	29,0	16,6	755.15.10.800.9	47,4	11,4	755.15.16.800.9	72,7	31,3
800	315	925	225	625	755.15.06.800.10	29,0	18,7	755.15.10.800.10	47,4	12,7	755.15.16.800.10	72,7	35,2
800	355	965	225	625	755.15.06.800.11	29,0	21,1	755.15.10.800.11	47,4	14,6	755.15.16.800.11	72,7	39,7
800	400	1010	200	600	755.15.06.800.12	29,0	23,7	755.15.10.800.12	47,4	16,4	755.15.16.800.12	72,7	44,7
900	90	690	150	600	755.15.06.900.13	32,7	5,40	755.15.10.900.13	53,3	18,2	755.15.16.900.13	81,8	10,1
900	110	720	175	625	755.15.06.900.1	32,7	6,60	755.15.10.900.1	53,3	20,5	755.15.16.900.1	81,8	12,3
900	125	735	175	625	755.15.06.900.2	32,7	7,40	755.15.10.900.2	53,3	22,7	755.15.16.900.2	81,8	14,0
900	140	750	175	625	755.15.06.900.3	32,7	8,30	755.15.10.900.3	53,3	25,4	755.15.16.900.3	81,8	15,7
900	160	770	175	625	755.15.06.900.4	32,7	9,50	755.15.10.900.4	53,3	28,6	755.15.16.900.4	81,8	17,9
900	180	790	200	650	755.15.06.900.5	32,7	10,7	755.15.10.900.5	53,3	32,2	755.15.16.900.5	81,8	20,1
900	200	810	200	650	755.15.06.900.6	32,7	11,9	755.15.10.900.6	53,3	36,3	755.15.16.900.6	81,8	22,4
900	225	835	220	670	755.15.06.900.7	32,7	13,4	755.15.10.900.7	53,3	46,0	755.15.16.900.7	81,8	25,2
900	250	860	225	675	755.15.06.900.8	32,7	14,8	755.15.10.900.8	53,3	58,0	755.15.16.900.8	81,8	27,9
900	280	890	225	675	755.15.06.900.9	32,7	16,6	755.15.10.900.9	53,3	68,0	755.15.16.900.9	81,8	31,3
900	315	925	250	700	755.15.06.900.10	32,7	18,7	755.15.10.900.10	53,3	8,2	755.15.16.900.10	81,8	35,2
900	355	965	250	700	755.15.06.900.11	32,7	21,1	755.15.10.900.11	53,3	10,0	755.15.16.900.11	81,8	39,7
900	400	1010	250	700	755.15.06.900.12	32,7	23,7	755.15.10.900.12	53,3	11,4	755.15.16.900.12	81,8	44,7
1000	90	810	150	650	755.15.06.1000.13	36,3	5,40	755.15.10.1000.13	59,3	12,7	755.15.16.1000.13	90,9	10,1
1000	110	830	175	675	755.15.06.1000.1	36,3	6,60	755.15.10.1000.1	59,3	14,6	755.15.16.1000.1	90,9	12,3
1000	125	845	175	675	755.15.06.1000.2	36,3	7,40	755.15.10.1000.2	59,3	16,4	755.15.16.1000.2	90,9	14,0
1000	140	880	175	675	755.15.06.1000.3	36,3	8,30	755.15.10.1000.3	59,3	18,2	755.15.16.1000.3	90,9	15,7
1000	160	880	175	675	755.15.06.1000.4	36,3	9,50	755.15.10.1000.4	59,3	20,5	755.15.16.1000.4	90,9	17,9
1000	180	900	200	700	755.15.06.1000.5	36,3	10,7	755.15.10.1000.5	59,3	22,7	755.15.16.1000.5	90,9	20,1
1000	200	920	200	700	755.15.06.1000.6	36,3	11,9	755.15.10.1000.6	59,3	25,4	755.15.16.1000.6	90,9	22,4

PE 100 Inegal TEE Calculation Table

da1 mm	da2 mm	L mm	I mm	z mm	SDR 26 - PN 6			SDR 17 - PN 10			SDR 11 - PN 15		
					Code	S1 mm	S2 mm	Code	S1 mm	S2 mm	Code	S1 mm	S2 mm
1000	225	945	220	720	755.15.06.1000.7	36,3	13,4	755.15.10.1000.7	59,3	28,6	755.15.16.1000.7	90,9	25,2
1000	250	970	225	725	755.15.06.1000.8	36,3	14,8	755.15.10.1000.8	59,3	32,2	755.15.16.1000.8	90,9	27,9
1000	280	1000	225	725	755.15.06.1000.9	36,3	16,6	755.15.10.1000.9	59,3	36,3	755.15.16.1000.9	90,9	31,3
1000	315	1035	250	750	755.15.06.1000.10	36,3	18,7	755.15.10.1000.10	59,3	8,02	755.15.16.1000.10	90,9	35,2
1000	355	1085	250	750	755.15.06.1000.11	36,3	21,1	755.15.10.1000.11	59,3	10,0	755.15.16.1000.11	90,9	39,7
1000	400	1120	250	750	755.15.06.1000.12	36,3	23,7	755.15.10.1000.12	59,3	11,4	755.15.16.1000.12	90,9	44,7
1200	90	810	150	750	755.15.06.1200.13	43,5	5,40	755.15.10.1200.13	70,6	12,7	755.15.16.1200.13	109,1	10,1
1200	110	840	175	775	755.15.06.1200.1	43,5	6,60	755.15.10.1200.1	70,6	14,6	755.15.16.1200.17	109,1	12,3
1200	125	855	175	775	755.15.06.1200.2	43,5	7,40	755.15.10.1200.2	70,6	11,4	55.15.16.1200.2	109,1	14,0
1200	140	870	175	775	755.15.06.1200.3	43,5	8,30	755.15.10.1200.3	70,6	12,7	755.15.16.1200.3	109,1	15,7
1200	160	890	175	775	755.15.06.1200.4	43,5	9,50	755.15.10.1200.4	70,6	14,6	755.15.16.1200.4	109,1	17,9
1200	180	910	200	800	755.15.06.1200.5	43,5	10,7	755.15.10.1200.5	70,6	16,4	755.15.16.1200.5	109,1	20,1
1200	200	930	200	800	755.15.06.1200.6	43,5	11,9	755.15.10.1200.6	70,6	18,2	755.15.16.1200.6	109,1	22,4
1200	225	955	220	820	755.15.06.1200.7	43,5	13,4	755.15.10.1200.7	70,6	20,5	755.15.16.1200.7	109,1	25,2
1200	250	980	225	825	755.15.06.1200.8	43,5	14,8	755.15.10.1200.8	70,6	22,7	755.15.16.1200.8	109,1	27,9
1200	280	1010	225	825	755.15.06.1200.9	43,5	16,6	755.15.10.1200.9	70,6	25,4	755.15.16.1200.9	109,1	31,3
1200	315	1045	250	850	755.15.06.1200.10	43,5	18,7	755.15.10.1200.10	70,6	28,6	755.15.16.1200.10	109,1	35,2
1200	355	1085	250	850	755.15.06.1200.11	43,5	21,1	755.15.10.1200.11	70,6	32,2	755.15.16.1200.11	109,1	39,7
1200	400	1130	250	850	755.15.06.1200.12	43,5	23,7	755.15.10.1200.12	70,6	36,3	755.15.16.1200.12	109,1	44,7

PE Pipe Fittings

Calculation Tables

PE 100 Reduction

ISO 4427-3

TS EN 12201-3 + A1

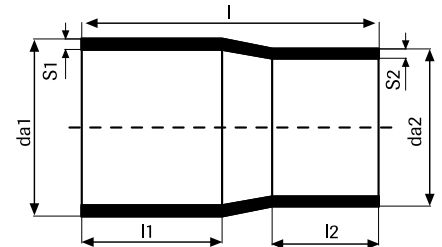

PE 100 Reducer Calculation Table

da1 / da2 mm	L mm	L1 mm	L2 mm	SDR 17 - PN 10			SDR 11 - PN 16		
				Code	S1 mm	S2 mm	Code	S1 mm	S2 mm
25-20	87	41	41	755.18.10.25.0	2,0	2,0	755.18.16.25.0	2,3	2,0
32-20	95	44	41	755.18.10.32.0	2,0	2,0	755.18.16.32.0	3,0	2,0
32-25	100	44	41	755.18.10.32.1	2,0	2,0	755.18.16.32.1	3,0	2,3
40-20	105	49	41	755.18.10.40.0	2,4	2,0	755.18.16.40.0	3,7	2,0
40-25	105	49	41	755.18.10.40.1	2,4	2,0	755.18.16.40.1	3,7	2,3
40-32	115	49	44	755.18.10.40.2	2,4	2,0	755.18.16.40.2	3,7	3,0
50-25	115	55	41	755.18.10.50.0	3,0	2,0	755.18.16.50.0	4,6	2,3
50-32	115	55	44	755.18.10.50.1	3,0	2,0	755.18.16.50.1	4,6	3,0
50-40	115	55	49	755.18.10.50.2	3,0	2,4	755.18.16.50.2	4,6	3,7
63-32	132	63	44	755.18.10.63.0	3,8	2,0	755.18.16.63.0	5,8	3,0
63-40	132	63	49	755.18.10.63.1	3,8	2,4	755.18.16.63.1	5,8	3,7
63-50	146	63	55	755.18.10.63.2	3,8	3,0	755.18.16.63.2	5,8	4,6
75-32	150	70	44	755.18.10.75.0	4,5	2,0	755.18.16.75.0	6,8	3,0
75-40	150	70	49	755.18.10.75.1	4,5	2,4	755.18.16.75.1	6,8	3,7
75-50	150	70	55	755.18.10.75.2	4,5	3,0	755.18.16.75.2	6,8	4,6
75-63	150	70	63	755.18.10.75.3	4,5	3,8	755.18.16.75.3	6,8	5,8
90-50	166	79	55	755.18.10.90.0	5,4	3,0	755.18.16.90.0	8,2	4,6
90-63	166	79	63	755.18.10.90.1	5,4	3,8	755.18.16.90.1	8,2	5,8
90-75	190	79	70	755.18.10.90.2	5,4	4,5	755.18.16.90.2	8,2	6,8
110-50	192	82	55	755.18.10.110.0	6,6	3,0	755.18.16.110.0	10,0	4,6
110-63	182	82	63	755.18.10.110.1	6,6	3,8	755.18.16.110.1	10,0	5,8
110-75	185	82	70	755.18.10.110.2	6,6	4,5	755.18.16.110.2	10,0	6,8
110-90	182	82	79	755.18.10.110.3	6,6	5,4	755.18.16.110.3	10,0	8,2
125-63	193	87	63	755.18.10.125.0	7,4	3,8	755.18.16.125.0	11,4	5,8
125-75	192	87	70	755.18.10.125.1	7,4	4,5	755.18.16.125.1	11,4	6,8
125-90	192	87	79	755.18.10.125.2	7,4	5,4	755.18.16.125.2	11,4	8,2
125-110	200	87	82	755.18.10.125.3	7,4	6,6	755.18.16.125.3	11,4	10,0
140-75	210	92	70	755.18.10.140.0	8,3	4,5	755.18.16.140.0	12,7	6,8
140-90	210	92	79	755.18.10.140.1	8,3	5,4	755.18.16.140.1	12,7	8,2
140-110	200	92	82	755.18.10.140.2	8,3	6,6	755.18.16.140.2	12,7	10,0

PE 100 Reducer Calculation Table

da1 / da2 mm	L mm	L1 mm	L2 mm	SDR 9 - PN 20			SDR 7.4 - PN 25		
				Code	S1 mm	S2 mm	Code	S1 mm	S2 mm
25-20	87	41	41	755.18.20.25.0	3,0	2,3	755.18.25.25.0	3,5	3,0
32-20	95	44	41	755.18.20.32.0	3,6	2,3	755.18.25.32.0	4,4	3,0
32-25	100	44	41	755.18.20.32.1	3,6	3,0	755.18.25.32.1	4,4	3,5
40-20	105	49	41	755.18.20.40.0	4,5	2,3	755.18.25.40.0	5,5	3,0
40-25	105	49	41	755.18.20.40.1	4,5	2,3	755.18.25.40.1	5,5	3,5
40-32	115	49	44	755.18.20.40.2	4,5	3,6	755.18.25.40.2	5,5	4,4
50-25	115	55	41	755.18.20.50.0	5,6	3,0	755.18.25.50.0	6,9	3,5
50-32	115	55	44	755.18.20.50.1	5,6	3,6	755.18.25.50.1	6,9	4,4
50-40	115	55	49	755.18.20.50.2	5,6	4,5	755.18.25.50.2	6,9	5,5
63-32	132	63	44	755.18.20.63.0	7,1	3,6	755.18.25.63.0	8,6	4,4
63-40	132	63	49	755.18.20.63.1	7,1	4,5	755.18.25.63.1	8,6	5,5
63-50	146	63	55	755.18.20.63.2	7,1	5,6	755.18.25.63.2	8,6	6,9
75-32	150	70	44	755.18.20.75.0	8,4	3,6	755.18.25.75.0	10,3	4,4
75-40	150	70	49	755.18.20.75.1	8,4	4,5	755.18.25.75.1	10,3	5,5
75-50	150	70	55	755.18.20.75.2	8,4	5,6	755.18.25.75.2	10,3	6,9
75-63	150	70	63	755.18.20.75.3	8,4	7,1	755.18.25.75.3	10,3	8,6
90-50	166	79	55	755.18.20.90.0	10,1	5,6	755.18.25.90.0	12,3	6,9
90-63	166	79	63	755.18.20.90.1	10,1	7,1	755.18.25.90.1	12,3	8,6
90-75	190	79	70	755.18.20.90.2	10,1	8,4	755.18.25.90.2	12,3	10,3
110-50	192	82	55	755.18.20.110.0	12,3	5,6	755.18.25.110.0	15,1	6,9
110-63	182	82	63	755.18.20.110.1	12,3	7,1	755.18.25.110.1	15,1	8,6
110-75	185	82	70	755.18.20.110.2	12,3	8,4	755.18.25.110.2	15,1	10,3
110-90	182	82	79	755.18.20.110.3	12,3	10,1	755.18.25.110.3	15,1	12,3
125-63	193	87	63	755.18.20.125.0	14,0	7,1	755.18.25.125.0	17,1	8,6
125-75	192	87	70	755.18.20.125.1	14,0	8,4	755.18.25.125.1	17,1	10,3
125-90	192	87	79	755.18.20.125.2	14,0	10,1	755.18.25.125.2	17,1	12,3
125-110	200	87	82	755.18.20.125.3	14,0	12,3	755.18.25.125.3	17,1	15,1
140-75	210	92	70	755.18.20.140.0	15,7	8,4	755.18.25.140.0	19,2	10,3
140-90	210	92	79	755.18.20.140.1	15,7	10,1	755.18.25.140.1	19,2	12,3
140-110	200	92	82	755.18.20.140.2	15,7	12,3	755.18.25.140.2	19,2	15,1

PE Pipe Fittings

Calculation Tables

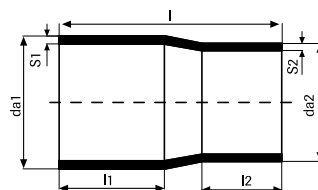

PE 100 Reduction

ISO 4427-3
TS EN 12201-3 + A1

PE 100 Reducer Calculation Table

da1 / da2 mm	L mm	L1 mm	L2 mm	SDR 17 - PN 10			SDR 11 - PN 16		
				Code	S1 mm	S2 mm	Code	S1 mm	S2 mm
140-125	200	92	87	755.18.10.140.3	8,3	7,4	755.18.16.140.3	12,7	11,4
160-75	235	98	70	755.18.10.160.4	9,5	4,5	755.18.16.160.4	14,6	6,8
160-90	232	98	79	755.18.10.160.0	9,5	5,4	755.18.16.160.0	14,6	8,2
160-110	220	98	82	755.18.10.160.1	9,5	6,6	755.18.16.160.1	14,6	10,0
160-125	215	98	87	755.18.10.160.2	9,5	7,4	755.18.16.160.2	14,6	11,4
160-140	205	98	92	755.18.10.160.3	9,5	8,3	755.18.16.160.3	14,6	12,7
180-90	250	105	79	755.18.10.180.0	10,7	5,4	755.18.16.180.0	16,4	8,2
180-110	245	105	82	755.18.10.180.1	10,7	6,6	755.18.16.180.1	16,4	10,0
180-125	235	105	87	755.18.10.180.2	10,7	7,4	755.18.16.180.2	16,4	11,4
180-140	230	105	92	755.18.10.180.3	10,7	8,3	755.18.16.180.3	16,4	12,7
180-160	225	105	98	755.18.10.180.4	10,7	9,5	755.18.16.180.4	16,4	14,6
200-90	280	112	79	755.18.10.200.3	11,9	5,4	755.18.16.200.3	18,2	8,2
200-110	265	112	82	755.18.10.200.4	11,9	6,6	755.18.16.200.4	18,2	10,0
200-125	260	112	87	755.18.10.200.5	11,9	7,4	755.18.16.200.5	18,2	11,4
200-140	255	112	92	755.18.10.200.0	11,9	8,3	755.18.16.200.0	18,2	12,7
200-160	245	112	98	755.18.10.200.1	11,9	9,5	755.18.16.200.1	18,2	14,6
200-180	235	112	105	755.18.10.200.2	11,9	10,7	755.18.16.200.2	18,2	16,4
225-140	275	120	92	755.18.10.225.0	13,4	8,3	755.18.16.225.0	20,5	12,7
225-160	270	120	98	755.18.10.225.1	13,4	9,5	755.18.16.225.1	20,5	14,6
225-180	260	120	105	755.18.10.225.2	13,4	10,7	755.18.16.225.2	20,5	16,4
225-200	255	120	112	755.18.10.225.3	13,4	11,9	755.18.16.225.3	20,5	18,2
250-160	300	130	98	755.18.10.250.0	14,8	9,5	755.18.16.250.0	22,7	14,6
250-180	290	130	105	755.18.10.250.1	14,8	10,7	755.18.16.250.1	22,7	16,4
250-200	275	130	112	755.18.10.250.2	14,8	11,9	755.18.16.250.2	22,7	18,2
250-225	270	130	120	755.18.10.250.3	14,8	13,4	755.18.16.250.3	22,7	20,5
280-125	325	139	87	755.18.10.280.3	16,6	7,4	755.18.16.280.3	25,4	11,4
280-180	320	139	105	755.18.10.280.0	16,6	10,7	755.18.16.280.0	25,4	16,4
280-200	315	139	112	755.18.10.280.1	16,6	11,9	755.18.16.280.1	25,4	18,2
280-225	305	139	120	755.18.10.280.2	16,6	13,4	755.18.16.280.2	25,4	20,5
280-250	292	139	130	755.18.10.280.3	16,6	14,8	755.18.16.280.3	25,4	22,7
315-180	330	150	105	755.18.10.315.4	18,7	10,7	755.18.16.315.4	28,6	16,4
315-200	350	150	112	755.18.10.315.0	18,7	11,9	755.18.16.315.0	28,6	18,2
315-225	340	150	120	755.18.10.315.1	18,7	13,4	755.18.16.315.1	28,6	20,5
315-250	330	150	130	755.18.10.315.2	18,7	14,8	755.18.16.315.2	28,6	22,7
315-280	315	150	139	755.18.10.315.3	18,7	16,6	755.18.16.315.3	28,6	25,4
355-160	378	165	98	755.18.10.355.4	21,1	9,5	755.18.16.355.4	32,2	14,6
355-180	380	165	105	755.18.10.355.5	21,1	10,7	755.18.16.355.5	32,2	16,4
355-200	380	165	112	755.18.10.355.6	21,1	11,9	755.18.16.355.6	32,2	18,2
355-225	380	165	120	755.18.10.355.0	21,1	13,4	755.18.16.355.0	32,2	20,5
355-250	375	165	130	755.18.10.355.1	21,1	14,8	755.18.16.355.1	32,2	22,7
355-280	365	165	139	755.18.10.355.2	21,1	16,6	755.18.16.355.2	32,2	25,4
355-315	350	165	150	755.18.10.355.3	21,1	18,7	755.18.16.355.3	32,2	28,6
400-225	430	180	120	755.18.10.400.0	23,7	13,4	755.18.16.400.0	36,3	20,5
400-250	430	180	130	755.18.10.400.1	23,7	14,8	755.18.16.400.1	36,3	22,7
400-280	415	180	139	755.18.10.400.2	23,7	16,6	755.18.16.400.2	36,3	25,4

PE 100 Reducer Calculation Table

da1 / da2 mm	L mm	L1 mm	L2 mm	SDR 9 - PN 20			SDR 7.4 - PN 25		
				Code	S1 mm	S2 mm	Code	S1 mm	S2 mm
140-125	200	92	87	755.18.20.140.3	15,7	14,0	755.18.25.140.3	19,2	17,1
160-90	232	98	79	755.18.20.160.0	17,9	10,1	755.18.25.160.0	21,9	12,3
160-110	220	98	82	755.18.20.160.1	17,9	12,3	755.18.25.160.1	21,9	15,1
160-125	215	98	87	755.18.20.160.2	17,9	14,0	755.18.25.160.2	21,9	17,1
160-140	205	98	92	755.18.20.160.3	17,9	10,1	755.18.25.160.3	21,9	19,2
180-90	250	105	79	755.18.20.180.0	20,1	10,1	755.18.25.180.0	24,6	12,3
180-110	245	105	82	755.18.20.180.1	20,1	12,3	755.18.25.180.1	24,6	15,1
180-125	235	105	87	755.18.20.180.2	20,1	14,0	755.18.25.180.2	24,6	17,1
180-140	230	105	92	755.18.20.180.3	20,1	10,1	755.18.25.180.3	24,6	19,2
180-160	225	105	98	755.18.20.180.4	20,1	17,9	755.18.25.180.4	24,6	21,9
200-140	255	112	92	755.18.20.200.0	22,4	10,1	755.18.25.200.0	27,4	19,2
200-160	245	112	98	755.18.20.200.1	22,4	17,9	755.18.25.200.1	27,4	21,9
200-180	235	112	105	755.18.20.200.2	22,4	20,1	755.18.25.200.2	27,4	24,6
225-140	275	120	92	755.18.20.225.0	25,2	10,1	755.18.25.225.0	30,8	19,2
225-160	270	120	98	755.18.20.225.1	25,2	17,9	755.18.25.225.1	30,8	21,9
225-180	260	120	105	755.18.20.225.2	25,2	20,1	755.18.25.225.2	30,8	24,6
225-200	255	120	112	755.18.20.225.3	25,2	22,4	755.18.25.225.3	30,8	27,4
250-160	300	130	98	755.18.20.250.0	27,9	17,9	755.18.25.250.0	34,2	21,9
250-180	290	130	105	755.18.20.250.1	27,9	20,1	755.18.25.250.1	34,2	24,6
250-200	275	130	112	755.18.20.250.2	27,9	22,4	755.18.25.250.2	34,2	27,4
250-225	270	130	120	755.18.20.250.3	27,9	25,2	755.18.25.250.3	34,2	30,8
280-180	320	139	105	755.18.20.280.0	31,3	20,1	755.18.25.280.0	38,3	24,6
280-200	315	139	112	755.18.20.280.1	31,3	22,4	755.18.25.280.1	38,3	27,4
280-225	305	139	120	755.18.20.280.2	31,3	25,2	755.18.25.280.2	38,3	30,8
280-250	282	139	130	755.18.20.280.3	31,3	27,9	755.18.25.280.3	38,3	34,2
315-200	350	150	112	755.18.20.315.0	35,2	22,4	755.18.25.315.0	43,1	27,4
315-225	340	150	120	755.18.20.315.1	35,2	25,2	755.18.25.315.1	43,1	30,8
315-250	330	150	130	755.18.20.315.2	35,2	27,9	755.18.25.315.2	43,1	34,2
315-280	315	150	139	755.18.20.315.3	35,2	31,3	755.18.25.315.3	43,1	38,3
355-225	380	165	120	755.18.20.355.0	39,7	25,2	755.18.25.355.0	48,5	30,8
355-250	375	165	130	755.18.20.355.1	39,7	27,9	755.18.25.355.1	48,5	34,2
355-280	365	165	139	755.18.20.355.2	39,7	31,3	755.18.25.355.2	48,5	38,3
355-315	350	165	150	755.18.20.355.3	39,7	35,2	755.18.25.355.3	48,5	43,1
400-225	430	180	120	755.18.20.400.0	44,7	25,2	755.18.25.400.0	54,7	30,8
400-250	430	180	130	755.18.20.400.1	44,7	27,9	755.18.25.400.1	54,7	34,2
400-280	415	180	139	755.18.20.400.2	44,7	31,3	755.18.25.400.2	54,7	38,3

PE Pipe Fittings

Calculation Tables

PE 100 Reduction

ISO 4427-3
TS EN 12201-3 + A1

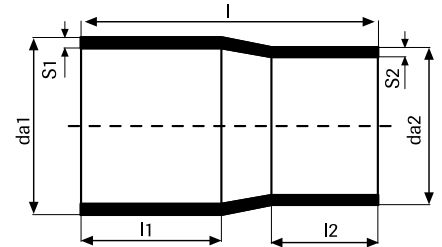

PE 100 Reducer Calculation Table

da1 / da2 mm	L mm	L1 mm	L2 mm	SDR 17 - PN 10			SDR 11 - PN 16		
				Code	S1 mm	S2 mm	Code	S1 mm	S2 mm
400-315	395	180	150	755.18.10.400.3	23,7	18,7	755.18.16.400.3	36,3	28,6
400-355	380	180	165	755.18.10.400.4	23,7	21,1	755.18.16.400.4	36,3	32,2
450-280	465	195	139	755.18.10.450.0	26,7	16,6	755.18.16.450.0	40,9	25,4
450-315	445	195	150	755.18.10.450.1	26,7	18,7	755.18.16.450.1	40,9	28,6
450-355	435	195	165	755.18.10.450.2	26,7	21,1	755.18.16.450.2	40,9	32,2
450-400	415	195	180	755.18.10.450.3	26,7	23,7	755.18.16.450.3	40,9	36,3
500-315	505	215	150	755.18.10.500.0	29,7	18,7	755.18.16.500.0	45,4	28,6
500-355	490	215	165	755.18.10.500.1	29,7	21,1	755.18.16.500.1	45,4	32,2
500-400	475	215	180	755.18.10.500.2	29,7	23,7	755.18.16.500.2	45,4	36,3
500-450	450	215	195	755.18.10.500.3	29,7	26,7	755.18.16.500.3	45,4	40,9
560-355	560	235	165	755.18.10.560.0	33,2	21,1	755.18.16.560.0	50,8	32,2
560-400	540	235	180	755.18.10.560.1	33,2	23,7	755.18.16.560.1	50,8	36,3
560-450	515	235	195	755.18.10.560.2	33,2	26,7	755.18.16.560.2	50,8	40,9
560-500	500	235	215	755.18.10.560.3	33,2	29,7	755.18.16.560.3	50,8	45,4
630-400	615	255	180	755.18.10.630.0	37,4	23,7	755.18.16.630.0	57,2	36,3
630-450	590	255	195	755.18.10.630.1	37,4	26,7	755.18.16.630.1	57,2	40,9
630-500	565	255	215	755.18.10.630.2	37,4	29,7	755.18.16.630.2	57,2	45,4
630-560	545	255	235	755.18.10.630.3	37,4	33,2	755.18.16.630.3	57,2	50,8
710-500	655	280	215	755.18.10.710.0	42,1	29,7	755.18.16.710.1	64,5	45,4
710-560	630	280	235	755.18.10.710.1	42,1	33,2	755.18.16.710.2	64,5	50,8
710-630	600	280	255	755.18.10.710.2	42,1	37,4	755.18.16.710.3	64,5	57,2
800-560	700	280	235	755.18.10.800.0	47,4	33,2	755.18.16.800.1	72,6	50,8
800-630	665	280	255	755.18.10.800.1	47,4	37,4	755.18.16.800.2	72,6	57,2
800-710	630	280	280	755.18.10.800.2	47,4	42,1	755.18.16.800.3	72,6	64,5
900-630	765	300	255	755.18.10.900.0	53,3	37,4	755.18.16.900.1	81,7	57,2
900-710	725	300	280	755.18.10.900.1	53,3	42,1	755.18.16.900.2	81,7	64,5
900-800	655	300	280	755.18.10.900.2	53,3	47,4	755.18.16.900.3	81,7	72,6
1000-710	805	300	280	755.18.10.1000.0	59,3	42,1	755.18.16.100.1	90,8	64,5
1000-800	735	300	280	755.18.10.1000.1	59,3	47,4	755.18.16.100.2	90,8	72,6
1000-900	675	300	300	755.18.10.1000.2	59,3	53,3	755.18.16.100.3	90,8	81,7
1200-800	890	300	280	755.18.10.1200.1	71,1	47,4	755.18.16.120.1	109,1	72,6
1200-900	830	300	300	755.18.10.1200.2	71,1	53,3	755.18.16.120.2	109,1	81,7
1200-1000	730	300	300	755.18.10.1200.3	71,1	59,3	755.18.16.120.3	109,1	90,8

PE 100 Reducer Calculation Table

da1 / da2 mm	L mm	L1 mm	L2 mm	SDR 9 - PN 20			SDR 7.4 - PN 25		
				Code	S1 mm	S2 mm	Code	S1 mm	S2 mm
400-315	360	180	150	755.18.20.400.3	44,7	35,2	755.18.25.400.3	54,7	43,1
400-355	365	180	165	755.18.20.400.4	44,7	39,7	755.18.25.400.4	54,7	48,5
450-280	364	195	139	755.18.20.450.0	50,3	31,3	755.18.25.450.0	61,5	38,3
450-315	375	195	150	755.18.20.450.1	50,3	35,2	755.18.25.450.1	61,5	43,1
450-355	390	195	165	755.18.20.450.2	50,3	39,7	755.18.25.450.2	61,5	48,5
450-400	395	195	180	755.18.20.450.3	50,3	44,7	755.18.25.450.3	61,5	54,7
500-315	395	215	150	755.18.20.500.0	55,8	35,2			
500-355	410	215	165	755.18.20.500.1	55,8	39,7			
500-400	415	215	180	755.18.20.500.2	55,8	44,7			
500-450	430	215	195	755.18.20.500.3	55,8	50,3			
560-355	425	235	165	755.18.20.560.1	62,5	39,7			
560-400	440	235	180	755.18.20.560.2	62,5	44,7			
560-450	455	235	195	755.18.20.560.3	62,5	50,3			
560-500	475	235	215	755.18.20.560.4	62,5	55,8			
630-400	460	255	180	755.18.20.630.1	70,3	44,7			
630-450	475	255	195	755.18.20.630.2	70,3	50,3			
630-500	495	255	215	755.18.20.630.3	70,3	55,8			
630-560	515	255	235	755.18.20.630.4	70,3	62,5			
710-500	500	260	215	755.18.20.710.1	79,3	55,8			
710-560	520	260	235	755.18.20.710.2	79,3	62,5			
710-630	540	260	255	755.18.20.710.3	79,3	70,3			
800-560	530	270	235	755.18.20.800.1	89,3	62,5			
800-630	550	270	255	755.18.20.800.2	89,3	70,3			
800-710	555	270	260	755.18.20.800.3	89,3	70,3			
900-630	580	300	255						
900-710	585	300	260						
900-800	595	300	270						
1000-710	585	300	260						
1000-800	595	300	270						
1000-900	625	300	300						

PE Pipe Fittings

Calculation Tables

PE 100 Short Type Reduction*

ISO 4427-3
TS EN 12201-3 + A1

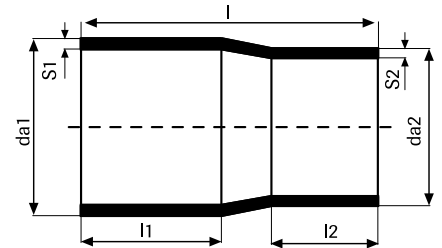

PE 100 Short Type Reducer Calculation Table

da1 / da2 mm	L mm	L1 mm	L2 mm	SDR 17 - PN 10			SDR 11 - PN 16		
				Code	S1 mm	S2 mm	Code	S1 mm	S2 mm
450-280	465	195	139	755.20.10.450.1	26.7	16.6	755.20.16.450.1	40,9	25,4
450-315	445	195	150	755.20.10.450.2	26.7	18.7	755.20.16.450.2	40,9	28,6
450-355	435	195	165	755.20.10.450.3	26.7	21.1	755.20.16.450.3	40,9	32,2
450-400	250	80	130	755.20.10.450.4	26.7	23.7	755.20.16.450.4	40,9	36,3
500-315	260	80	140	755.20.10.500.1	29.7	18.7	755.20.16.500.1	45,4	28,6
500-355	270	80	150	755.20.10.500.2	29.7	21.1	755.20.16.500.2	45,4	32,2
500-400	280	80	160	755.20.10.500.3	29.7	23.7	755.20.16.500.3	45,4	36,3
500-450	270	80	150	755.20.10.500.4	29.7	26.7	755.20.16.500.4	45,4	40,9
560-355	390	80	150	755.20.10.560.1	33.2	21.1	755.20.16.560.1	50,8	32,2
560-400	345	100	120	755.20.10.560.2	33.2	23.7	755.20.16.560.2	50,8	36,3
560-450	305	100	120	755.20.10.560.3	33.2	26.7	755.20.16.560.3	50,8	40,9
560-500	270	100	120	755.20.10.560.4	33.2	29.7	755.20.16.560.4	50,8	45,4
630-400	400	100	120	755.20.10.630.1	37.4	23.7	755.20.16.630.1	57,2	36,3
630-450	360	100	120	755.20.10.630.2	37.4	26.7	755.20.16.630.2	57,2	40,9
630-500	315	100	120	755.20.10.630.3	37.4	29.7	755.20.16.630.3	57,2	45,4
630-560	275	100	120	755.20.10.630.4	37.4	33.2	755.20.16.630.4	57,2	50,8
710-500	340	100	120	755.20.10.710.1	42.1	29.7	755.20.16.710.1	64,5	45,4
710-560	335	100	120	755.20.10.710.2	42.1	33.2	755.20.16.710.2	64,5	50,8
710-630	285	100	120	755.20.10.710.3	42.1	37.4	755.20.16.710.3	64,5	57,2
800-560	300	60	120	755.20.10.800.1	47.4	33.2	755.20.16.800.1	72,6	50,8
800-630	280	60	120	755.20.10.800.2	47.4	37.4	755.20.16.800.2	72,6	57,2
800-710	230	60	120	755.20.10.800.3	47.4	42.1	755.20.16.800.3	72,6	64,5
900-630	230	60	120	755.20.10.900.1	53.3	37.4	755.20.16.900.1	81,7	57,2
900-710	230	60	120	755.20.10.900.2	53.3	42.1	755.20.16.900.2	81,7	64,5
900-800	250	60	120	755.20.10.900.3	53.3	47.4	755.20.16.900.3	81,7	72,6
1000-710	280	60	120	755.20.10.100.1	59.3	42.1	755.20.16.100.1	90,8	64,5
1000-800	280	60	120	755.20.10.100.2	59.3	47.4	755.20.16.100.2	90,8	72,6
1000-900	280	60	120	755.20.10.100.3	59.3	53.3	755.20.16.100.3	90,8	81,7
1200-800	280	60	120	755.20.10.120.1	71.1	47.4	755.20.16.120.1	109,1	72,6
1200-900	280	60	120	755.20.10.120.2	71.1	53.3	755.20.16.120.2	109,1	81,7
1200-1000	280	60	120	755.20.10.120.3	71.1	59.3	755.20.16.120.3	109,1	90,8

* Short Type Reducer is only suitable for butt welded jointing.

PE 100 Short Type Reducer Calculation Table

da1 / da2 mm	L mm	L1 mm	L2 mm	SDR 9 - PN 20			SDR 7.4 - PN 25		
				Code	S1 mm	S2 mm	Code	S1 mm	S2 mm
450-280	465	195	139	755.20.20.450.1	50.3	31.3	755.20.25.450.1	61,5	38,3
450-315	445	195	150	755.20.20.450.2	50.3	35.2	755.20.25.450.2	61,5	43,1
450-355	435	195	165	755.20.20.450.3	50.3	39.7	755.20.25.450.3	61,5	48.5
450-400	250	80	130	755.20.20.450.4	50.3	44.7	755.20.25.450.4	61,5	54.7
500-315	260	80	140	755.20.20.500.1	55.8	35.2			
500-355	270	80	150	755.20.20.500.2	55.8	39.7			
500-400	280	80	160	755.20.20.500.3	55.8	44.7			
500-450	270	80	150	755.20.20.500.4	55.8	50.3			
560-355	390	80	150	755.20.20.560.1	62.5	39.7			
560-400	345	100	120	755.20.20.560.2	62.5	44.7			
560-450	305	100	120	755.20.20.560.3	62.5	50.3			
560-500	270	100	120	755.20.20.560.4	62.5	55.8			
630-400	400	100	120	755.20.20.630.1	70.3	44.7			
630-450	360	100	120	755.20.20.630.2	70.3	50.3			
630-500	315	100	120	755.20.20.630.3	70.3	55.8			
630-560	275	100	120	755.20.20.630.4	70.3	62.5			
710-500	340	100	120	755.20.20.710.1	79.3	55.8			
710-560	335	100	120	755.20.20.710.2	79.3	62.5			
710-630	285	100	120	755.20.20.710.3	79.3	70.3			
800-560	300	60	120	755.20.20.800.1	89.3	62.5			
800-630	280	60	120	755.20.20.800.2	89.3	70.3			
800-710	230	60	120	755.20.20.800.3	89.3	79.3			
900-630	230	60	120						
900-710	230	60	120						
900-800	250	60	120						
1000-710	280	60	120						
1000-800	280	60	120						
1000-900	280	60	120						
1200-800	280	60	120						
1200-900	280	60	120						
1200-1000	280	60	120						

PE Pipe Fittings

Calculation Tables

PE 100 Flange Adapter

ISO 4427-3

TS EN 12201-3 + A1

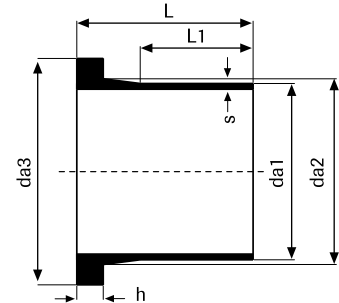

PE 100 Flange Adapter Calculation Table

SDR 26 - PN 6							SDR 17 - PN 10							SDR 11 - PN 16						
da1 mm	da2 mm	da3 mm	L mm	L1 mm	h mm	s mm	da1 mm	da2 mm	da3 mm	L mm	L1 mm	h mm	s mm	da1 mm	da2 mm	da3 mm	L mm	L1 mm	h mm	s mm
20							20							20	27	45	61	41	7	2.0
25							25	33	58	63	41	9	2.0	25	33	58	63	41	9	2.3
32							32	40	68	67	44	10	2.0	32	40	68	67	44	10	3.0
40							40	50	78	75	49	11	2.4	40	50	78	75	49	11	3.7
50							50	61	88	82	55	12	3.0	50	61	88	82	55	12	4.6
63	75	91	87	63	14	2.5	63	75	102	95	63	14	3.8	63	75	102	95	63	14	5.8
75	89	111	106	70	16	2.9	75	89	122	106	70	16	4.5	75	89	122	106	70	16	6.8
90	105	128	116	79	17	3.5	90	105	138	140	79	17	5.4	90	105	138	140	79	17	8.2
110	125	148	125	82	18	4.2	110	125	158	160	82	18	6.6	110	125	158	160	82	18	10.0
125	132	148	132	87	25	4.8	125	132	158	170	87	25	7.4	125	170	158	170	87	25	11.4
140	155	188	189	92	25	5.4	140	155	188	189	92	25	8.3	140	155	188	189	92	25	12.7
160	175	201	200	98	25	6.2	160	175	212	200	147	25	9.5	160	175	212	200	147	25	14.6
180	185	201	165	105	30	6.9	180	185	212	165	105	30	10.7	180	185	212	165	105	30	16.4
200	232	257	185	112	32	7.7	200	232	268	185	112	32	11.9	200	232	268	185	112	32	18.2
225	235	257	182	120	32	8.6	225	235	268	182	120	32	13.4	225	235	268	182	120	32	20.5
250	285	309	195	130	35	9.6	250	285	320	205	130	35	14.8	250	285	320	205	130	35	22.7
280	291	309	205	139	35	10.7	280	291	320	205	139	35	16.6	280	291	320	205	139	35	25.4
315	335	365	225	150	35	12.1	315	335	370	225	150	35	18.7	315	335	370	225	150	35	28.6
355	373	415	245	165	40	13.6	355	373	430	245	165	40	21.1	355	373	430	245	165	40	32.2
400	427	466	275	180	46	15.3	400	427	482	275	180	46	23.7	400	427	482	275	180	46	36.3
450	462	524	315	195	60	17.2	450	462	535	315	195	60	26.7	450	462	535	315	195	60	40.9
500	530	569	325	215	60	19.1	500	530	585	325	215	60	29.7	500	530	585	325	215	60	45.4
560	615	669	355	235	60	21.4	560	615	685	355	235	60	33.2	560	615	685	355	235	60	50.8
630	642	669	355	255	60	24.1	630	642	685	355	255	60	37.4	630	642	685	355	255	60	57.2
710	737	776	390	280	60	27.2	710	737	800	390	280	60	42.1	710	737	800	390	280	60	64.5
800	840	878	390	280	60	30.6	800	840	905	390	280	60	47.4	800	840	905	390	280	60	72.6
900	944	978	350	240	60	34.4	900	944	1005	350	240	60	53.3	900	944	1005	350	240	60	81.7
1000	1047	1081	350	250	60	38.2	1000	1047	1115	350	250	60	59.3	1000	1047	1115	350	250	60	90.8
1200	1245	1300	400	315	60	45.9	1200	1245	1330	400	315	60	71.1	1200	1245	1330	400	315	60	109.1
1400	1450	1510	400	270	80	53.5	1400	1450	1535	400	270	80	83.0							
1600	1645	1720	400	270	80	61.2	1600	1645	1645	400	270	80	94.8							

FIRAT may change some values in the calculation tables provided that standard requirements are satisfied due to design purposes. Please contact FIRAT infrastructure pipe marketing department for diameter and pressure classes which are not contained in the tables.

PE 100 Flange Adapter Calculation Table

SDR 9 - PN 20							SDR 7.4 - PN 25						
da1 mm	da2 mm	da3 mm	L mm	L1 mm	h mm	s mm	da1 mm	da2 mm	da3 mm	L mm	L1 mm	h mm	s mm
20	27	45	63	41	9	2.3	20	27	45	64	41	10	3.0
25	33	58	64	41	10	3.0	25	33	58	65	41	11	3.5
32	40	68	68	44	11	3.6	32	40	68	69	44	12	4.4
40	50	78	76	49	12	4.5	40	50	78	77	49	13	5.5
50	61	88	83	55	13	5.6	50	61	88	84	55	14	6.9
63	75	102	100	63	15	7.1	63	75	102	100	63	16	8.6
75	89	122	107	70	17	8.4	75	89	122	108	70	18	10.3
90	105	138	117	79	18	10.2	90	105	138	118	79	19	12.3
110	125	158	126	82	19	12.3	110	125	158	127	82	20	15.1
125	132	158	133	87	26	14.0	125	134	158	135	87	27	17.1
140	145	188	152	92	25	15.7	140	145	188	152	92	27	19.2
160	175	212	152	98	25	17.9	160	175	212	163	98	27	21.9
180	185	212	165	105	30	20.1	180	185	212	165	105	30	24.6
200	232	268	185	112	32	22.4	200	232	268	185	112	32	27.4
225	235	268	185	120	32	25.2	225	235	268	185	120	32	30.8
250	285	320	205	130	35	27.9	250	285	320	205	130	35	34.2
280	291	320	220	139	35	31.3	280	291	320	220	139	35	38.3
315	335	370	230	150	35	35.2	315	335	370	230	150	35	43.1
355	373	430	255	165	45	39.7	355	373	430	250	165	45	48.5
400	427	482	275	180	46	44.7							
450	462	535	315	195	60	50.3							
500	530	585	325	215	60	55.8							
560	615	685	355	235	60	62.5							
630	642	685	355	255	60	70.3							
710	737	800	390	280	60	79.3							
800	840	905	390	280	60	89.3							

PE Pipe Fittings

Calculation Tables

PE 100 Short Type Flange Adapter

ISO 4427-3

TS EN 12201-3 + A1

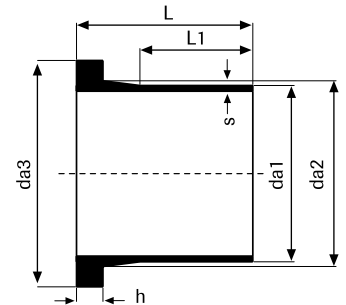

PE 100 Short Type Flange Adapter Calculation Table

SDR 26 - PN 6							SDR 17 - PN 10						
da1 mm	da2 mm	da3 mm	L mm	L1 mm	h mm	s mm	da1 mm	da2 mm	da3 mm	L mm	L1 mm	h mm	s mm
500	530	569	215	105	60	19.1	500	530	585	215	105	60	29.7
560	615	669	225	105	60	21.4	560	615	685	225	105	60	33.2
630	642	669	175	75	60	24.1	630	642	685	175	75	60	37.4
710	737	774	180	70	60	27.2	710	737	800	180	70	60	42.1
800	840	878	180	70	60	30.6	800	840	905	180	70	60	47.4
900	944	978	180	70	60	34.4	900	944	1005	180	70	60	53.3
1000	1047	1081	200	70	60	38.2	1000	1047	1115	200	70	60	59.3
1200	1245	1300	200	70	60	45.9	1200	1245	1330	200	70	60	71.1
1400	1450	1510	200	85	80	53.5	1400	1450	1535	200	85	80	83.0
1600	1645	1720	200	80	80	61.2	1600	1645	1737	200	80	80	94.8

SDR 11 - PN 16							SDR 9 - PN 20						
da1 mm	da2 mm	da3 mm	L mm	L1 mm	h mm	s mm	da1 mm	da2 mm	da3 mm	L mm	L1 mm	h mm	s mm
500	530	585	215	105	60	45.4	500	530	585	215	105	60	79.3
560	615	685	225	105	60	50.8	560	615	685	225	105	60	89.3
630	642	685	175	75	60	57.2							
710	737	800	180	70	60	64.5							
800	840	905	180	70	60	72.6							
900	944	1005	180	70	60	81.7							
1000	1047	1115	200	70	60	90.8							
1200	1245	1330	200	70	60	109.1							

* Short Type Flange Adapter is suitable for butt welded connection only.

Steel Flange (Galvanized)

TS EN 1092-1

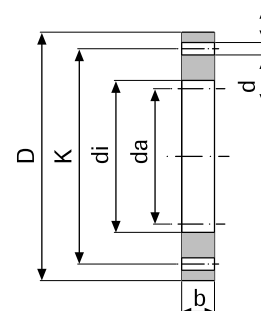

PE 100 Steel Flange (Galvanized) Calculation Table

Steel DN	PE		PN 6						PN 10						PN 16					
	da mm	di mm	K mm	D mm	d mm	n mm	b mm	Bolt mm	K mm	D mm	d mm	n mm	b mm	Bolt mm	K mm	D mm	d mm	n mm	b mm	Bolt mm
15	20	28	55	80	11	4	12	M 10	65	95	14	4	14	M 12	65	95	14	4	14	M 12
20	25	34	65	90	11	4	14	M 10	75	105	14	4	16	M 12	75	105	14	4	16	M 12
25	32	42	75	100	11	4	14	M 10	85	115	14	4	16	M 12	85	115	14	4	16	M 12
32	40	51	90	120	14	4	14	M 12	100	140	18	4	16	M 16	100	140	18	4	16	M 16
40	50	62	100	130	14	4	14	M 12	110	150	18	4	16	M 16	110	150	18	4	16	M 16
50	63	78	110	140	14	4	14	M 12	125	165	18	4	18	M 16	125	165	18	4	18	M 16
65	75	92	130	160	14	4	14	M 12	145	185	18	8	18	M 16	145	185	18	8	18	M 16
80	90	108	150	190	18	4	16	M 16	160	200	18	8	20	M 16	160	200	18	8	20	M 16
100	110	125	170	210	18	4	16	M 16	180	220	18	8	20	M 16	180	220	18	8	20	M 16
100	125	135	170	210	18	4	16	M 16	180	220	18	8	20	M 16	180	220	18	8	20	M 16
125	140	158	200	240	18	8	18	M 16	210	250	18	8	22	M 16	210	250	18	8	22	M 16
150	160	178	225	265	18	8	18	M 16	240	285	22	8	22	M 20	240	285	22	8	22	M 20
150	180	188	225	265	18	8	18	M 16	240	285	22	8	22	M 20	240	285	22	8	22	M 20
200	200	235	280	320	18	8	20	M 16	295	340	22	8	24	M 20	295	340	22	12	24	M 20
200	225	238	280	320	18	8	20	M 16	295	340	22	8	24	M 20	295	340	22	12	24	M 20
250	250	288	335	375	18	12	22	M16	350	395	22	12	26	M 20	355	405	26	12	26	M 24
250	280	294	335	375	18	12	22	M 16	350	395	22	12	26	M 20	355	405	26	12	26	M 24
300	315	338	395	440	22	12	22	M 20	400	445	22	12	26	M 20	410	460	26	12	28	M 24
350	355	376	445	490	22	12	22	M 20	460	505	22	16	26	M 20	470	520	26	16	30	M 24
400	400	430	495	540	22	16	22	M 20	515	565	26	16	26	M 24	525	580	30	16	32	M 27
450	450	465	550	595	22	16	24	M 20	565	615	26	20	28	M 24	585	640	30	20	34	M 27
500	500	533	600	645	22	20	24	M 20	620	670	26	20	28	M 24	650	715	33	20	34	M 30
600	560	618	705	755	26	20	24	M 24	725	780	30	20	28	M 27	770	840	36	20	36	M 33
600	630	645	705	755	26	20	24	M 24	725	780	30	20	28	M 27	770	840	36	20	36	M 33
700	710	740	810	860	26	24	24	M 24	840	895	30	24	30	M 27	840	910	36	24	36	M 33
800	800	843	920	975	30	24	24	M 27	950	1015	33	24	32	M 30	950	1025	39	24	38	M 36
900	900	947	1020	1075	30	24	26	M 27	1050	1115	33	28	34	M 30	1050	1125	39	28	40	M 36
1000	1000	1050	1120	1175	30	28	26	M 27	1160	1230	36	28	34	M 33	1170	1255	42	28	42	M 39
1200	1200	1250	1340	1405	33	32	28	M 30	1380	1455	39	32	38	M 36	1390	1485	48	32	48	M 45
1400	1400	1460	1560	1630	36	36	32	M 33	1590	1675	42	36	42	M 39	1590	1685	48	36	52	M 45
1600	1600	1650	1760	1830	36	40	32	M 33	1820	1915	48	40	46	M 45	1820	1930	55	40	58	M 52

PE Pipe Fittings

Calculation Tables

Steel Blind Flange (Galvanized)



PE 100 Steel Blind Flange (Galvanized) Calculation Table

Steel DN	PE	PN 6						PN 10						PN 16					
	da mm	K mm	D mm	d mm	n mm	b mm	Bolt mm	K mm	D mm	d mm	n mm	b mm	Bolt mm	K mm	D mm	d mm	n mm	b mm	Bolt mm
15	20	55	80	11	4	12	M 10	65	95	14	4	14	M 12	65	95	14	4	14	M 12
20	25	65	90	11	4	14	M 10	75	105	14	4	16	M 12	75	105	14	4	16	M 12
25	32	75	100	11	4	14	M 10	85	115	14	4	16	M 12	85	115	14	4	16	M 12
32	40	90	120	14	4	14	M 12	100	140	18	4	16	M 16	100	140	18	4	16	M 16
40	50	100	130	14	4	14	M 12	110	150	18	4	16	M 16	110	150	18	4	16	M 16
50	63	110	140	14	4	14	M 12	125	165	18	4	18	M 16	125	165	18	4	18	M 16
65	75	130	160	14	4	14	M 12	145	185	18	8	18	M 16	145	185	18	8	18	M 16
80	90	150	190	18	4	16	M 16	160	200	18	8	20	M 16	160	200	18	8	20	M 16
100	110	170	210	18	4	16	M 16	180	220	18	8	20	M 16	180	220	18	8	20	M 16
100	125	170	210	18	4	16	M 16	180	220	18	8	20	M 16	180	220	18	8	20	M 16
125	140	200	240	18	8	18	M 16	210	250	18	8	22	M 16	210	250	18	8	22	M 16
150	160	225	265	18	8	18	M 16	240	285	22	8	22	M 20	240	285	22	8	22	M 20
150	180	225	265	18	8	18	M 16	240	285	22	8	22	M 20	240	285	22	8	22	M 20
200	200	280	320	18	8	20	M 16	295	340	22	8	24	M 20	295	340	22	12	24	M 20
200	225	280	320	18	8	20	M 16	295	340	22	8	24	M 20	295	340	22	12	24	M 20
250	250	335	375	18	12	22	M16	350	395	22	12	26	M 20	355	405	26	12	26	M 24
250	280	335	375	18	12	22	M 16	350	395	22	12	26	M 20	355	405	26	12	26	M 24
300	315	395	440	22	12	22	M 20	400	445	22	12	26	M 20	410	460	26	12	28	M 24
350	355	445	490	22	12	22	M 20	460	505	22	16	26	M 20	470	520	26	16	30	M 24
400	400	495	540	22	16	22	M 20	515	565	26	16	26	M 24	525	580	30	16	32	M 27
450	450	550	595	22	16	24	M 20	565	615	26	20	28	M 24	585	640	30	20	34	M 27
500	500	600	645	22	20	24	M 20	620	670	26	20	28	M 24	650	715	33	20	34	M 30
600	560	705	755	26	20	24	M 24	725	780	30	20	28	M 27	770	840	36	20	36	M 33
600	630	705	755	26	20	24	M 24	725	780	30	20	28	M 27	770	840	36	20	36	M 33
700	710	810	860	26	24	24	M 24	840	895	30	24	30	M 27	840	910	36	24	36	M 33
800	800	920	975	30	24	24	M 27	950	1015	33	24	32	M 30	950	1025	39	24	38	M 36
900	900	1020	1075	30	24	26	M 27	1050	1115	33	28	34	M 30	1050	1125	39	28	40	M 36
1000	1000	1120	1175	30	28	26	M 27	1160	1230	36	28	34	M 33	1170	1255	42	28	42	M 39
1200	1200	1340	1405	33	32	28	M 30	1380	1455	39	32	38	M 36	1390	1485	48	32	48	M 45
1400	1400	1560	1630	36	36	32	M 33	1590	1675	42	36	42	M 39	1590	1685	48	36	52	M 45
1600	1600	1760	1830	36	40	32	M 33	1820	1915	48	40	46	M 45	1820	1930	55	40	58	M 52

Joining Methods of PE Pipes

Electrofusion Welding

Electrofusion welding process of polyethylene pipes are carried out pursuant to international standard such as DVS 2207.

Welding is carried out with heating resistors at the muff section in electrofusion welding method. After placing the pipes into the muff, ends of the welding machine are connected to the heating element ends of the Coupler inside the hole and heating elements are heated by current. Since wall thickness of the Coupler is thicker than the wall thickness of the pipe, temperature of the pipe wall is higher than the temperature of Coupler wall. Pressure is generated inside the pipe due to this temperature difference. Fusion is realized with the pressure on the pipe and pressure generated in the pipe. Electrofusion welding machines used for welding process are light and they also ensure welding with variable welding parameters or usage of information documents of the performed welds.

- Pipes made of same raw material can be welded in electrofusion welding process.
- Melting flow rate is at the range of 0.2-1.4 g/10 min. (190°C/5 kg) for HDPE-electrofusion welding. Melting flow rate of pipes and Couplers to be welded shall be between these values. Pipes with identical melting flow rate can be welded.
- Welding area shall be protected against adverse weather conditions. (For instance: Snow, rain, wind and strong sun rays etc.)
- Temperature of the welding environment shall be between 5°C and 50°C.
- Electrofusion welding machines generally bear barcode scanners and electrofusion fittings contain barcodes which indicate welding parameters. Welding parameters are loaded to the machine through the barcode and welding parameters inscribed on the fitting can be loaded manually to the welding machine for welding.

Welding Parameters

Latest welding machines have barcode scanners attached to them. Welding parameters of EF fitting to be welded are inscribed as a barcode or attached on the Coupler or contained in the package.



Joining Methods of PE Pipes

Electrofusion Coupler Welding Procedure

1 Ends of the pipes to be welded shall be cut flat and smooth and placed in the fitting to be welded until it stops, insertion limit is marked on the pipe.

2 Surface of the pipe to be welded shall be cleaned and surface oxidation shall be cleared by scraping prior to welding.

3 Fittings to be welded shall be taken off their package during welding state and electrofusion surfaces to be welded shall be cleaned with industrial alcohol, contact with hands shall be avoided upon cleaning the welding surfaces of pipe and fittings.

4 Later, fitting to be welded shall be inserted to the marked section of the pipe until it stops in the fitting.

5 It shall be checked to be flat with the pipes with electrofusion welding end pointing upwards and fixed. Sockets of the welding machine is placed on the welding ends of the fitting and rendered ready for welding.

6 When the machine signals ready for welding barcode is scanned or welding parameters are entered manually to commence welding. Generally, welding machines display welding time and voltage on the screen and finalize welding process automatically and signal completion alert.

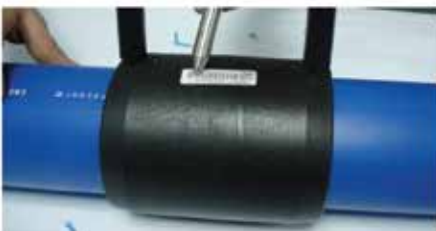
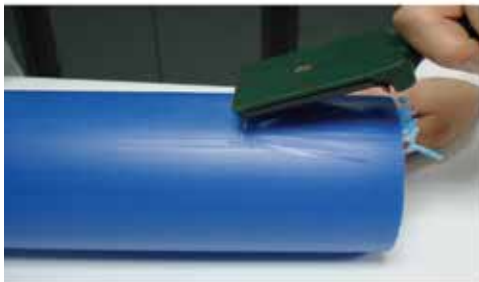

Electrofusion Service T Welding Procedure

1 Distance of the pipe to be installed and to remain inside the Service T area is scraped to remove the oxidation layer.

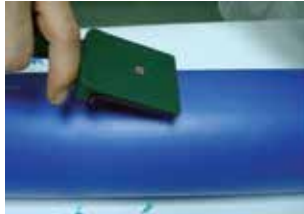

2 Oxidation layer on the pipe is removed, pipe surface, interior surface of Service T to be welded, rotating head welding surface and output end is cleaned with industrial alcohol.



3 Lower part of the Service T is placed in the lower section of the pipe.

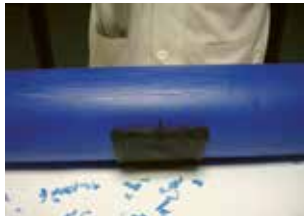

4 Service T is placed in the lower section by aligning the inserting grooves.



5 Screws available in the package are tightened crosswise.



6 Cables of the welding machine are installed to the pole ends found on Service T.



7 Label on the fitting is scanned with Welding Machine Barcode Scanner. Machine signals START for commencing welding process. Welding location shall never be moved during welding process.



8 Kaynak soğuma süresinden sonra Servis T üst kapağı sola çevrilerek açılır. ettirilmemelidir.



9 Blade mechanism located on Service T top point is rotated clockwise with 14 mm Allen wrench to cut the pipe.



10 Upon completion of the pipe cutting process Allen wrench is rotated counter clockwise to fully tighten the blade mechanism on the top point.



11 Service T top cover is fully tightened by rotating clockwise. Installation is completed with this process.



Joining Methods of PE Pipes

Butt Welding

Polyethylene pipes can be manufactured to be connected by butt welding method according to the project. However, technical restrictions are present for both diameter and wall thickness in joining with this welding method. Joining with this welding method can be performed for diameters between 50 mm and 2500 mm and for wall thicknesses between 5 mm and 150 mm according to the diameters. Butt welding process is performed as per DVS 2207 standard.

Important issues to be paid attention while joining PE pipes using butt welding method:

- Temperature of the environment to perform butt welding shall not be under 5°C.
- Wall thicknesses of the pipes to be jointed shall be equal, in the case that there is difference, the maximum wall thickness difference between two pipes shall not be over 10%.
- Butt welding machine to be used for welding shall be certified.
- Prior to commencing the welding process surfaces to be welded shall be trimmed off and cleared from oxidation and full contact shall be ensured between welding surfaces.
- Soiling of the welding surface upon trimming shall always be prevented. If soiling is present, trimming process shall be performed again.
- Welding surface shall be cleaned with pure alcohol before being heated with ironer.
- Welding ironer temperature shall be between 200-220 °C and determined according to the raw material that the pipe is made of and the application standard. Higher temperature values shall be preferred for pipes with smaller wall thicknesses and lower temperature values shall be preferred for pipes with higher wall thicknesses.
- Upon commencement of the welding procedure, joining pressure values of the pipes shall be kept uniform throughout cooling.
- Since the air circulation generated inside the pipe speeds up the cooling process of welding in an unstable manner, one end of the pipes shall be blocked during welding process.
- Prior to commencing the welding process, temperature values of the machine shall be checked and welding shall commence 5 minutes after reaching to the desired temperature value.
- Ironer section of the machine and the welding section of the pipe shall be cleaned prior to the welding process.
- Welding pressure test for pressure potable water pipes performed as per EN 805 standard.



Butt Welding

Pipe Welding Area Calculation Formula:

$$A_{\text{Pipe}} = \frac{(d_a^2 - d_i^2) \cdot \pi}{4} \text{ (mm}^2\text{)}$$

or $\approx dm \cdot \pi \cdot s \text{ (mm}^2\text{)}$

- A_{pipe} : Pipe welding area
- d_a : Outer diameter
- d_i : Internal diameter
- dm : Intermediate diameter

Weld Compression Force Calculation:

$$F = p_{\text{Specific}} \cdot A_{\text{Pipe}} \text{ (N)}$$

- A_{pipe} : Pipe welding area
- F : Force for compression
- p_{specific} : PE = 0.15 N/mm²
- N : PP = 0.10 N/mm²

Butt Welding Stages

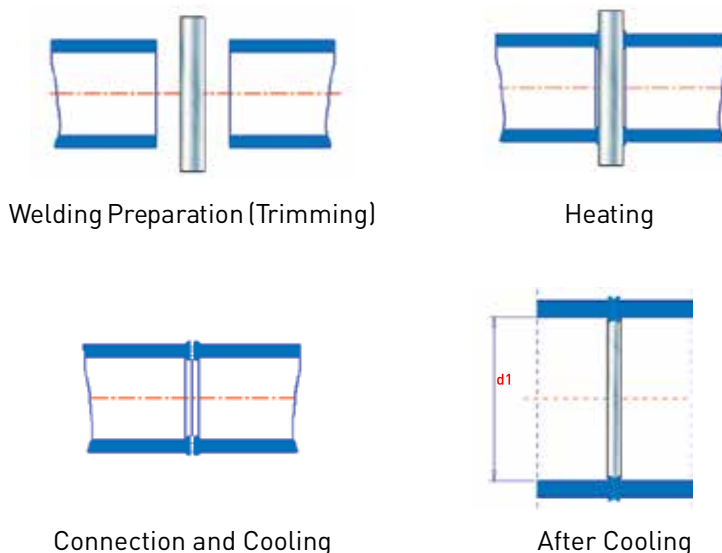

Butt Welding Process Time Graphic

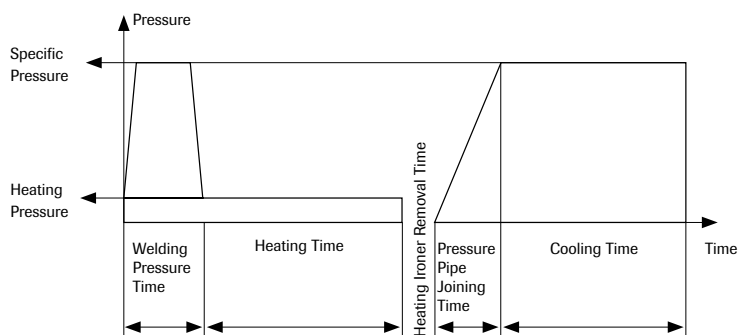

Optimal welding times of HDPE Pipes under 20°C Ambient Temperature

Pipe Wall Thickness (mm)	Welding Pressure 0.15 N / mm ² Bead-up Height (mm)	Heating Time 0.02 N / mm ² (sec)	Heating Ironer Removal Time (sec)	Pipe Welding Pressure Working Time (sec)
.....4,5	0.54555
4,5.....7	1.0	45.....70	5.....6	5.....6
7.....12	1.5	70.....120	6.....8	6.....8
12....19	2.0	120....190	8.....10	8.....11
19...26	2.5	190...260	10....12	11....14
26...37	3.0	260...370	12....16	14....19
37....50	3.5	370....500	16....20	19....25
50....70	4.0	500....700	20....25	25....35

Joining Methods of PE Pipes

Socket Fusion Welding

In this method, exterior surface of the pipe and interior surface of the fitting made of the same PE material are simultaneously heated using non-adhering aluminum forms. When surfaces melt sufficiently, heating molds are removed, pipe and fitting are engaged. Melted surfaces are engaged and they are cooled down to form a homogenous joint.

In principle, only same type of materials shall be joined (PE with PE). It is possible to joint small diameter pipes and fittings using this method and it is generally used for joining PPRC installation pipe and fittings.



Figure 8.2 Socket Fusion Welding

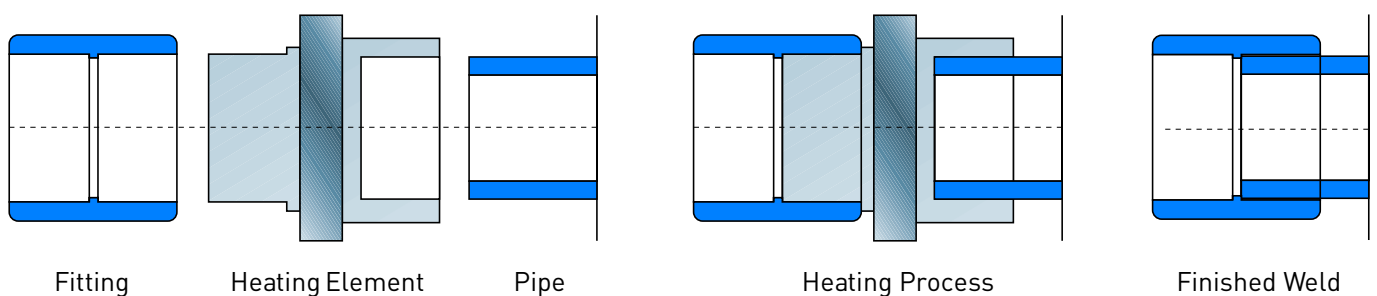

Extrusion Welding (Corner Welding)

PE pipes can be jointed with corner welding from inside and outside at muff insert points. Flat pipes built without muff can also be jointed with corner welding, however, this welding method is mainly used in production of fittings such as elbows, y-branches in special projects and special technical applications such as manhole and tank.

Corner welding may not be applied for joining pipes which will be employed in high-pressure lines, it can only be applied to pipes and manholes which will be used in low-pressure gravity lines. Extrusion welding machines are available in two types, both adopting the same operating principle.

- Hot air blowing welding machines with rod
- Hot air blowing welding machines which extrude the granule raw material

Corner welding (extrusion welding) process is performed as per DVS 2207 standard.



Important issues to be paid attention while joining PE pipes using corner welding method:

- Temperature of the environment to perform corner welding shall not be under 5°C.
- Corner welding shall not be used at gas pipe and pressure potable water lines.
- Material of the parts to be welded and welding rods shall be from the same class and diameters of the welding rods that are used shall be 3 or 4 mm.
- Surfaces to be welded shall be very clean, surface oxidation shall be scraped off right before commencing the welding process.
- While carrying out the welding process, welding extruder shall always be kept at an angle of 45° to the welding surface.
- For welding large and deep surfaces, welding with a maximum thickness of 4 mm shall be made at once, upon cooling it shall be cleaned with scraper again and another welding processes shall be carried out on the welded area; the procedure shall be repeated until the desired thickness is obtained.

Joining Methods of PE Pipes

Extrusion Welding (Corner Welding)

Corner welding Preparation

Corner welding Preparation Details

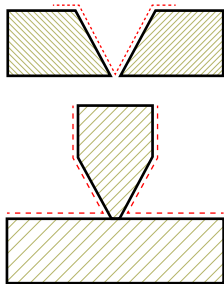

Corner welding Horizontal Edge Welding Methods

Double Side Horizontal Corner welding Appearance

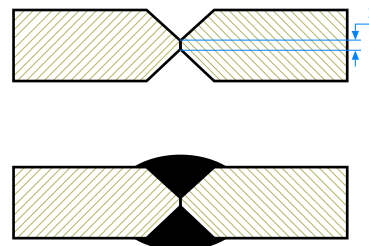

Corner welding Vertical Edge Welding Methods

Corner welding Horizontal Edge Welding Methods

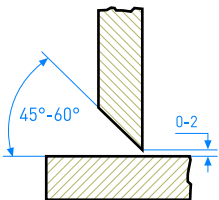

Single Side Vertical Corner welding Appearance

Single Side Horizontal Corner welding Appearance

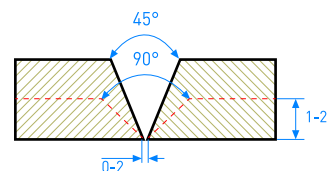

Before Welding

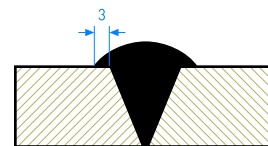

After Welding

DVS 2207 Corner welding Parameters (Ambient Temperature 20°C)

Class of the Material to be Welded	Welding Force (N)		Welding Extruder Hot Air Temperature Value (°C)	Hot Air Flow Rate (l/min)
	3 mm Electrode	4 mm Electrode		
HDPE	10...16	25...35	300...350	40...60
PP	10...16	25...35"	280...330	40...60

Output diameter of the hot air blowing tip of the extruder shall be 5 mm.

Flange Joining Method

Flange joining method is a method that is used when PE pipes are joined with equipment such as steel pipes, valves, pumps, compensator or the pipe line will be required to be dismantled in the future at certain points.

Steel ring named flange is passed around the PE pipe line and PE part which is named "flange adapter" is installed at the end of the pipe line having a rim to hold the steel ring and fused with butt welding. Two pipe lines to be joined with flange are brought against each other and upon placing seal between both rims, flanges are connected using nuts and bolts. The most important aspect to consider is to tighten the bolts in opposite fashion rather than progressing in a circular manner. While tightening the bolts pipe lines shall not be pulled and overloading shall be prevented.



Flange Joining Method

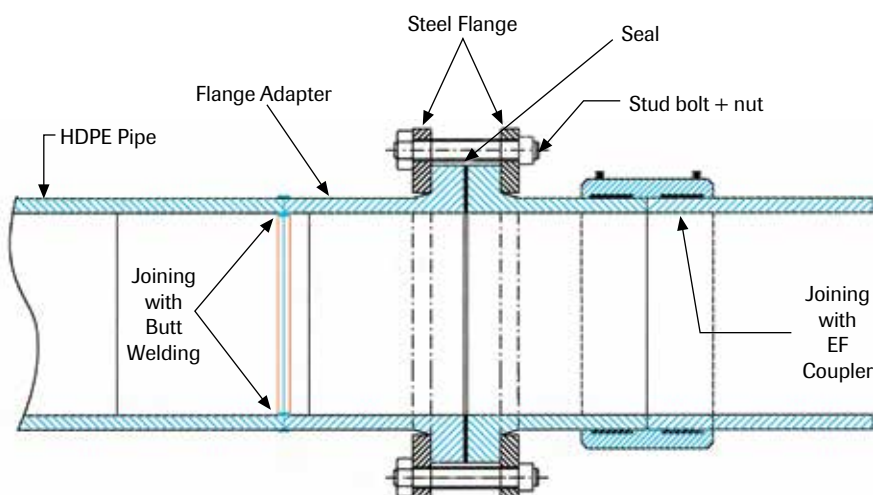

Joining Methods of PE Pipes

Coupling Adapter Joining Method

Pipes to be jointed to each other using coupling adapter shall be cut perpendicular to their axis and their ends are coned at an angle of 15° approximately and the pipe is pushed in to the recess inside the coupling by rotating. When both pipes are placed properly nuts are tightened by hand and joining is completed. In the case that pipe diameter is 40 mm or higher, nuts shall be tightened using a special wrench rather than tightening by hand. Coupling adapters withstand to a pressure of 16 bars, however, they are not recommended for pipes with diameter in excess of 110 mm.



Coupling Adapter Joining Method

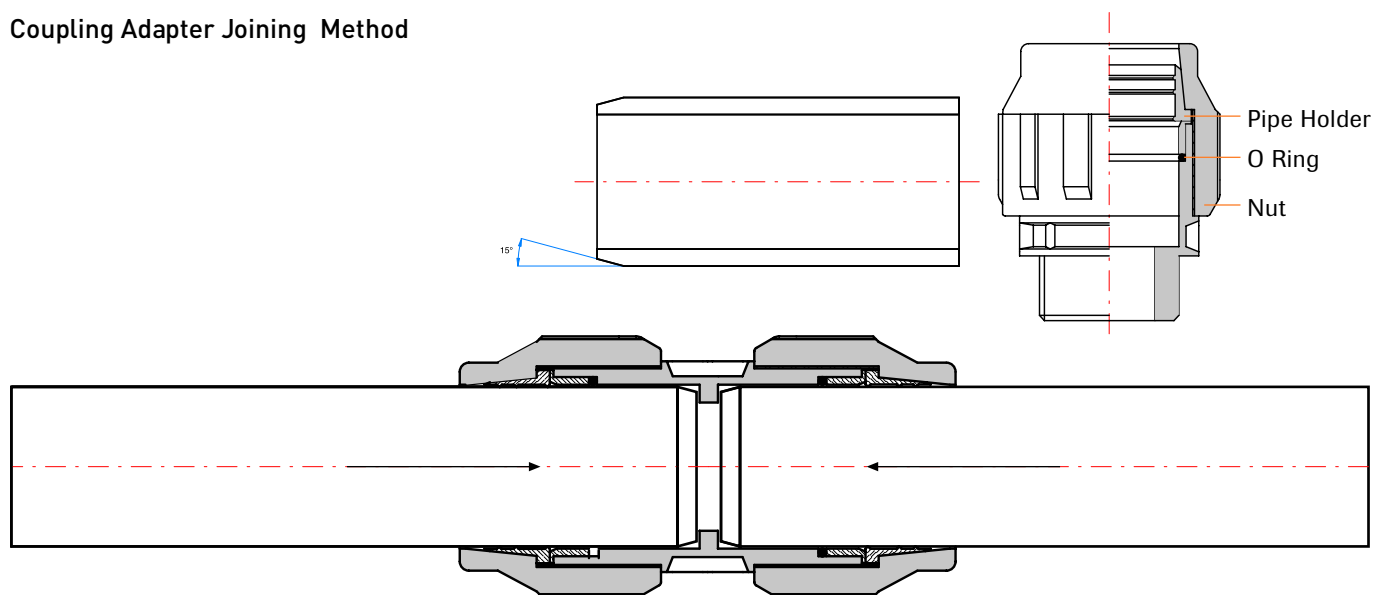

PE Pipe Laying Rules

PE pipe laying rules are specified in ATV-A 127 and EN 805 standards. Pipes can be laid inside the channel upon being welded outside the channel. Thus, channel excavation shall be kept narrow.

- Pipes shall never be crushed.
- Pipes which are damaged [damaged by pointed tools or materials such as rock] during shipping or storage shall never be used.
- No underground water or rain water accumulation shall be present inside the channel. (In the case that there is water accumulation inside the channel, water shall be discharged using a pump.)
- Nonadherent Sand, pebble, mixed sand and pebble blend are suitable for use as a filling material for the channel.
- Minimum channel depth shall be 70-80 cm.
- In the case that excavation soil is fit for filling, pipe can be laid directly on the bottom of the channel without requiring bedding. In the case that excavation soil is not fit for filling (stony, watery etc.) channel depth shall be increased and bedding shall be established using dry filling material (ex: sand).
- Minimum bedding thickness to be established shall be $A1 = 100 \text{ mm} + 1/10 \text{ DN}$. Bedding material shall be compacted with a lightweight compactor until 95 % compaction is achieved.
- Pipe side fillings A2, shall be poured with a thickness of 30 cm and compacted at the rate of 95% using a light compactor. This process shall be repeated for each 30 cm until it covers top of the pipe 30 cm.
- When it covers the top of the pipe A3 = 30 cm, filling procedure shall be completed by compacting by using a medium power compactor.



Layout of the Pipe in the Channel

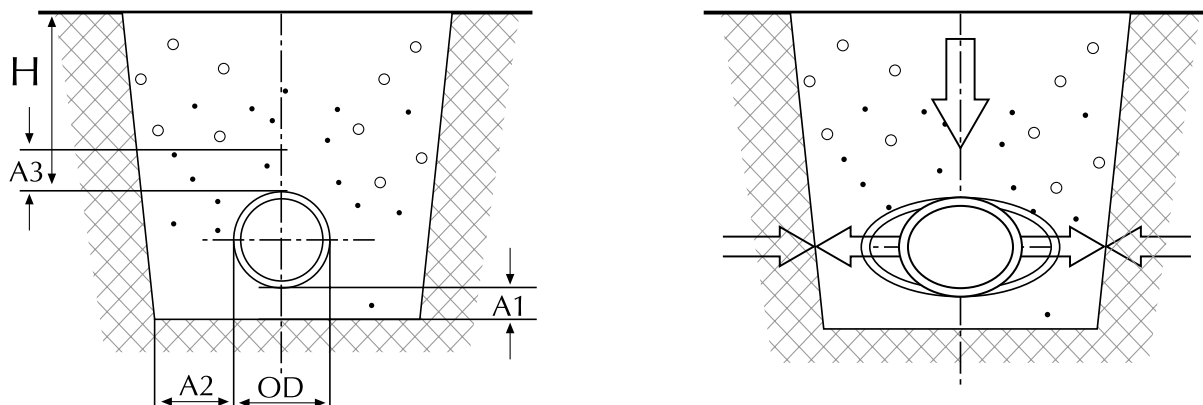

PE Pipeline Pressure Test



Pressure drop of PE Pipes

Pipe	Nominal Pressure	Pressure Reduction
HDPE	10	2
HDPE	16	3
LDPE	10	2

Note: Temperature of water filled in pipe system in line test and test ambient temperature are important. For conditions above 20°C, temperature dependent pressure reduction coefficients shall be used, test shall not be performed above 40°C.

$$\Delta V_{max} = 1,5 \cdot V \cdot \Delta p \cdot \left[\frac{1}{E_w} \frac{D}{e} \frac{1}{E_R} \right]$$

ΔV_{max} :admissible max. water output
 E_w :Water Compression Module (2000N/mm²)
 E_R :Elasticity Module for HDPE (800N/mm²)
 e :Pipe Wall Thickness



Standards
 EN 805 Water Supply - Requirement for systems and componenets outside buildings.

Procedure

Line pressure test shall be applied to pipelines which are installed by following the below procedure steps prior to introducing them to service.

a. Preliminary Test

1. Line is filled with water. Valve at the highest point shall be opened during filling and compressed air in the line is released
2. Line is closed.
3. Test pressure is determined as MDP (maximum design pressure) + 5 bar or PN x 1.5 (Whichever is lower).
4. The line is brought to the test pressure within 10 minutes using a suitable pump.
5. Pumping continues to stabilize the test pressure for 10 minutes.
6. Pump is stopped. Distribution line is left by itself for 60 minutes.
7. Pipeline is subjected to visco-elastic deformation. No more than 30% decrease shall occur within 60 minutes. Pressure decrease in excess of 30% indicates water leakage in the line or increase in temperature. Test is terminated in both cases. Pre-test is performed again by measuring all stresses on the line upon carrying out inspection and temperature check on the line.

b. Main Test

One of the two methods are preferred in the main test. 1. Pressure drop test Method

- Pressure of the line is reduced at the rate of the values in Table 1 after 60 minutes.
- Contraction time of 30 minutes is counted upon pressure education. Line is considered to be sealed if the pressure is maintained or increased for 30 minutes. Test time is extended to 1.5 hour in case of doubt. However, maximum 0.25 bar pressure reduction is admissible during this time. If more then 0.25 pressure reduction is observed it means that distribution line has leakage.

Water Volume Loss Method for Pressure Drop

- Volume of the water extracted during pressure drop is determined. (Vt)
- Max water volume which can be extracted from line is calculated using ΔV_{max} formula. If $V_t \leq V$ test is acceptable.

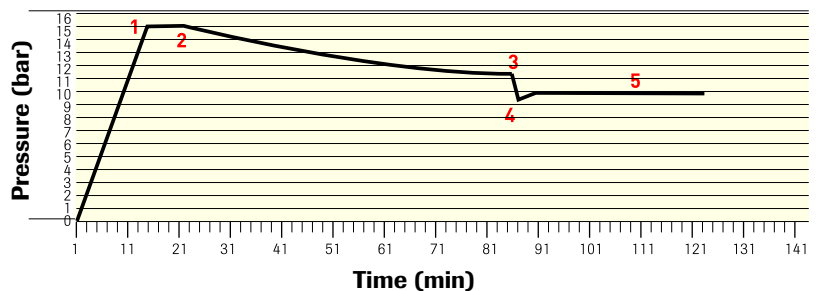

1. Pumping shall continue under test pressure for 30 minutes.
2. Test pressure shall be obtained within 10 minutes.
3. Pump shall be stopped and line shall be observed for 60 minutes.
4. If less than 30% decrease shall occur pressure shall be decreased 2 bars at once.
5. It is waited for 5.30 mins. If pressure remains constant or increases TEST IS SUCCESSFUL.

Packaging and Labeling

Pipes

Ø 20 - Ø 125 mm PE pipes are packaged in coils. Pipes over Ø 140 mm are manufactured in lengths of 12-13.5 m. Packaging over 100 m can be made for coil quantities upon request.

Required information are inscribed in 1 m intervals on the pipes in order to ensure retrospective traceability. Manufacturer's Name, Standard Number, Standard Logo, Pipe Raw Material, Pipe Diameter, Pipe Wall Thickness, SDR Group, Operating Pressure, Machine No and Production Date.

Packaging Information of PE Pipes

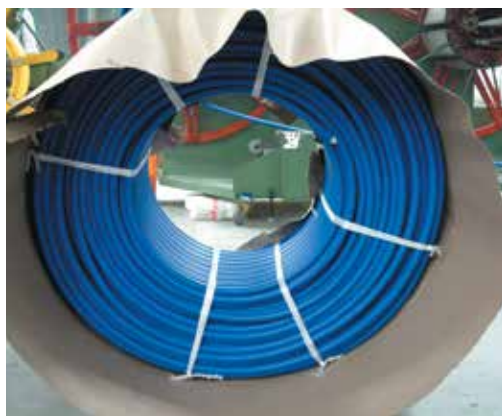

Diameter	Internal Ø	Outer Ø	Height	Length
Ø 20	40	70	20	100
Ø 25	50	85	22	100
Ø 32	65	100	34	100
Ø 40	80	120	38	100
Ø 50	100	140	40	100
Ø 63	130	160	50	100
Ø 75	150	200	55	100
Ø 90	180	230	60	100
Ø 110	220	280	85	100
Ø 125	250	300	105	100

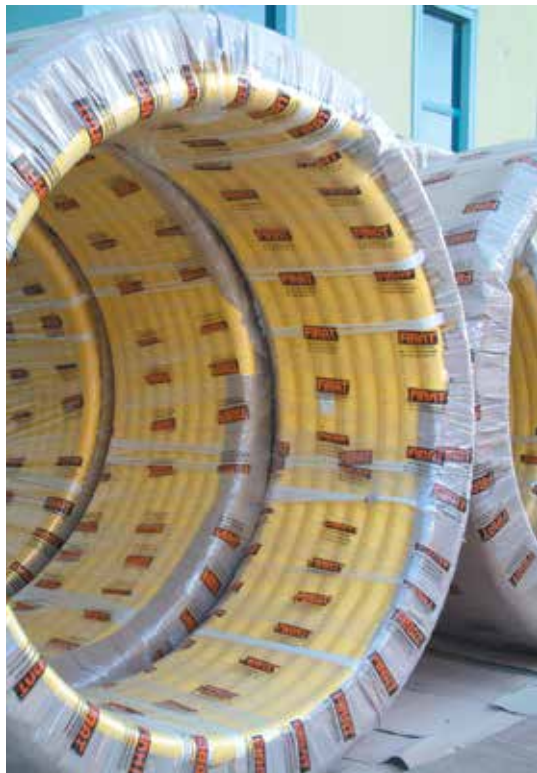

Shipping and Stocking Rules

Shipping and Stocking Rules

Box of the shipping vehicle shall be free from nails, hard objects, rocks etc. which can damage the pipes.

Pipes shall not be placed on the vehicle in an untidy manner; pipes shall not be thrown during unloading and loading.

Floor of the storage field shall be cleared of items which can damage the pipes.

When stocking pipes which are available in coils, height of the coils which will be placed on top of each other shall not exceed 1.5 m. Flat pipes can be stocked in two way:

1. Pyramid stocking,
2. Square stocking.



1. Pyramid Stocking

5 x 10 cm timbers are laid on the floor in 1 m intervals. Pipes are stocked on top of each other with one less pipe on each array in a pyramid fashion, height not exceeding 1.5 m. Side wedges shall be used to prevent slippage of pipes.



2. Square Stocking

Timbers are laid on the floor as in the pyramid system. Pipes are stocked up to 1.5 m height at 90° angle to the bottom array of pipes at each array. A cube with dimensions of 12 x 12 x 1.5 m shall be formed.

In order to prevent deformation in pipes caused by hot air during summer months, stocking height shall be limited with 1 m.

Blue pipes shall be protected against UV rays by being covered with canvas until they are ready for use.



Resistance to Chemicals

As a rule, lifespan of pipes which are made of materials such as steel and font ductile are determined according to decomposition degree due to corrosion. Corrosive effects are combined with wear and cause gradual thinning of pipe wall thickness and breakage or puncturing of the pipe in time due to stress.

Factors which impact the service life of the pipes that are made of plastic materials are different. Environments which are considered to be corrosive for iron and steel pipes have no effect on plastic pipes. Chemical resistance of plastics directly depend on the polymer decomposition. Plastic pipes are affected from cases such as UV radiation, thermal oxidization and water absorption. Carbon black, antioxidant substances and stabilizers which are called pigments are added in the refinery environment to prevent or delay decomposition. Table of chemicals to which PE pipes and fittings have resistance, limited resistance or no resistance is as follows.

PE 100 Pipes and Fittings Chemical Resistance Table

Name of the Substance	Concentration %	T(°C)	LDPE	HDPE
Adipic Acid	sat.sol % 1.4	20/60	D/D	D/D
Allyl Alcohol	ts-s	20/60	SD/DZ	D/D
Aluminum Hydroxide	süsp.	20/60	D/D	D/D
Ammoniac, dry gas	ts-g	20/60	D/D	D/D
Ammoniac, hydrous	sat.sol	20/60	D/D	D/D
Ammoniac, liquid	ts-g	20/60	SD/SD	D/D
Ammonium Chloride	sat.sol	20/60	D/D	D/D
Ammonium Sulfate	sat.sol	20/60	D/D	D/D
Aniline sat.sol	sat.sol	20/60	DZ/DZ	
Asetic Acid	50	20/60	D	D
Asetic Acid, glacial	≥ 96	20/60	SD/DZ	D/SD
Acetone ts-s	ts-s	20/60	SD/DZ	SD/SD
Copper (II) Sulfate	sat.sol	20/60	D/D	D/D
BenzenE ts-s	ts-s	20/60	DZ/DZ	SD/SD
Gasoline (Fuel)	o.sol	20/60	SD/DZ	D/SD
Beer	o.sol	20/60	D/D	D/D
Vegetable Oils	ts-s	20/60	D/SD	
Butane, gas	ts-g	20/60		D/D
Mercury ts-s	ts-s	20/60	D/D	D/D
Iron (II) and (III) Chloride	sat.sol	20/60	D/D	D/D
Ethanol	40	20/60	D/SD	D/SD
Ethylene Glycol	ts-s	20/60	D/D	D/D
Phenol	sol.	20/60	SD/DZ	D/D
Formaldehyde	30-40	20/60	D/D	D/D
Glycerin	ts-s	20/60	D/D	D/D
Air	ts-g	20/60	D/D	D/D
Hydrogen	ts-g	20/60	D/D	D/D
Hydrogen Peroxide	30	20/60	D/SD	D/D

PE 100 Boru ve Ek Parçaların Kimyasal Maddelere Dayanım Tablosu

Name of the Substance	Concentration %	T(°C)	LDPE	HDPE
Hydrochloric Acid	30 concentrated	20/60/20	D/D/D	D/D/D
Urine		20/60	D/D	D/D
Iodine (in alcohol)	o.sol.	20/60	DZ/DZ	DZ/DZ
Calcium Carbonate	susp.	20/60	D/D	D/D
Calcium Chloride	sat.sol.	20/60	D/D	D/D
Carbon dioxide, humid gas	ts-g	20/60	D/D	D/D
Carbon monoxide, gas	ts-g	20/60	D/D	D/D
Carbon Tetrachloride	ts-g	20/60	DZ/DZ	SD/DZ
Chlorine (dry gas)	ts-g	20/60	DZ/DZ	SD/DZ
Chlorinated Water	sat.sol.	20/60	DZ/DZ	SD/DZ
Chloroform	ts-s	20/60	DZ/DZ	DZ/DZ
Lead Acetat	sat.sol.	20/60	D/D	D/D
Sulfur Dioxide, dry gas		20/60	D/D	D/D
Methyl Alcohol	ts-s	20/60	D/SD	D/D
	10	20/60	D/D	D/D
Nitric Acid	25	20/60	D/D	D/D
Nitric Acid	≥ 50	20/60	DZ/DZ	DZ/DZ
Fuming Nitrogen (with oxide)		20/60	DZ/DZ	DZ/DZ
Oxygen, gas	ts-g	20/60	D	D/SD
Potassium Hydroxide	sol.	20/60	D/D	D/D
	up to %50	20/60		
Cyclohexanol	ts-s	20/60		D/D
Sodium Bicarbonate	sat.sol.	20/60	D/D	D/D
Vinegar	o.sol.	20/60	D/D	D/D
Sodium Hydroxide	sol.	20/60	D/D	D/D
	40	20/60	D/D	D/D
Sodium Carbonate	sat.sol.	20/60	D/D	D/D
	up to 50	20/60	D/D	D/D
Sodium Chloride	sat.sol.	20/60	D/D	D/D
Sodium Sulfate	sat.sol.	20/60	D/D	D/D
Water Distilled Sea		20/60	D/D	D/D
Water, Utility, Mineral	o.sol.	20/60	D/D	D/D
	10 30	20/60	D/D	D/D
Sulfuric Acid	50	20/60	D/D	D/D
	98	20/60	SD/DZ	D/DZ
	fuming	20/60	DZ/DZ	DZ/DZ
Milk	o.sol.	20/60	D/D	D/D
Wine	o.sol.	20/60	D/D	D/D
Toluene	ts-s	20/60	DZ/DZ	SD/DZ
Trichloroethylene	ts-s	20/60	DZ/DZ	DZ/DZ
Urea	sol.	20/60	D/D	D/D
Fats (vegetable or animal)	ts-s	20/60	SD/DZ	D/SD

Abbreviations and Definitions

D: Resistant

No adverse change occurs in the properties of plastic pipes and fittings which are indicated with “D” symbol in the table when used under specified temperatures and with chemicals with specific concentrations unless a mechanical factor acts on them.

SD: Limited Resistant

Certain amount of corrosion may occur with the plastic pipes and fittings which are indicated with “D” symbol in the table when used under specified temperatures and with chemicals with specific concentrations unless a mechanical factor acts on them. Therefore, pipes indicated with “SD” can be used in applications where minimal amount of corrosion is admissible.

DZ: Not Resistant

Plastic pipes and fittings which are indicated with “DZ” symbol in the table are not employed since they are highly affected by chemicals.

ts-s Technical purity, liquid

ts-g Technical purity, gas

sat.sol. Saturated solution

o.sol. Working solution, is the most widespread concentration used in industry

sol. Solution

Quality Assurance

Test Methods



Quality Assurance Test Methods

All tests required by the following standards are performed for the production and quality control of PE pipes. Our products are offered to use upon completion of controls and tests and obtaining FIRAT QUALITY CERTIFICATION.

1 Density Evaluation ISO 1183

It is performed to determine the weight of the material at unit volume. Density is found upon calculation by weighing the material in air then in the liquid which has a certain density with Analytical Balance.

2 MFR Evaluation (Melt Flow Rate) ISO 1133 Performed to analyze the behavior of the material prior to processing. Samples which are obtained upon the test that is performed by using MFR device are weighted on the analytical balance and the found values are loaded to the device and result is determined with g/10 min unit.

3 Elongation at break ISO 527

It is the test in which the elongation amount of the material at the instant of breaking is determined as %.

4 Hydrostatic Pressure Test ISO 1167

It is the test in which the pipes are subjected to internal hydrostatic stress under a certain temperature, pressure and time.

5 Pigment Dispersion ISO 18553

Performed to evaluate the homogeneity of the pigment distribution in the structure of the material. Microtome cross section with the thickness of 10-15 µm is analyzed under microscope.

6 Carbon Black Content ISO 6964

Performed to evaluate the carbon content in the structure of the pipe body as % in order to ensure resistance against UV Rays.

Quantity of the carbon which forms the unburned part of the sample which is burnt in the high temperature oven with nitrogen gas as %.

7 OIT Evaluation [Thermal Stability] EN 728

Thermal and oxygen effect of the pipe are subjected to shock conditioning and decomposition time is determined.



Technical Specifications for Polyethylene Pipes and Fittings

1.0 SCOPE

1.1 These technical specifications cover the properties pertaining to polyethylene pipes and fittings which are used for conveying pressure water.

2.0 RAW MATERIAL PROPERTIES

2.1 Raw material to be used in manufacture of pipes and fittings shall be PE 100 class raw material.

2.2 MRS value of the raw material shall be 10 MPa. Minimum peripheral stress shall be 8 N/mm².

2.3 Density shall be minimum 930 g/cm³ when tested according to ISO 1183 standard.

2.4 Melt Flow Rate shall be in the range of 0.2-1.4 g/10 min. under 190°C/5kg according to ISO 1133 standard.

2.5 Elongation at break shall be minimum 350% according to ISO 6259 standard.

2.6 Oxidation time shall be minimum 20 min. under 200°C when tested according to EN 728 standard.

3.0 PROPERTIES OF PIPES AND FITTINGS

3.1 Fittings manufactured from PE 100 raw material can be manufactured using injection molding or butt welding method. Fittings which are manufactured with both methods shall satisfy the requirements of TS EN 12201-3 standard.

3.2 When the color of pipes and fittings are checked with naked eye, appearance shall be homogenous at every point of the body.

3.3 Interior and exterior surface of the pipes and fittings shall be smooth and free of defects such as cavities, spaces, deep marks and scratches.

3.4 Sizes and tolerances of pipes and fittings Shall conform to TS EN 12201-2 and TS EN 12201-3 standards.

3.5 Pipes and fittings shall be healthy in terms of physiology and toxicology and shall not impair odor and taste of the water which passes through. Shall be certified with the reports of the Ministry of Health or independent laboratories that operate in Europe.

3.6 Fittings which will be jointed with electrofusion welding shall bear barcode label which contain welding parameters.

4.0 QUALITY DEEDS AND CERTIFICATES

4.1 Manufacturing companies are required to submit ISO 9001 and ISO 14001 certificates which cover PE pipes and fittings to the tender administration together with the offer file.

4.2 PE 100 pipes shall be manufactured according to TS EN 12201-2 standards, fittings shall be manufactured according to TS EN 12201-3 standards; manufacturing companies shall submit aforementioned valid TS certificates together with the offer file during the bidding process.



Standards

TS EN 12201-1

Plastic Pipe Systems for Water Supply, and for Drainage and Sewerage Under Pressure - Polyethylene (PE)
Part 1: General

TS EN 12201-2

Plastic Pipe Systems for Water Supply, and for Drainage and Sewerage Under Pressure - Polyethylene (PE)
Part 2: Pipes

TS EN 12201-3

Plastic Pipe Systems for Water Supply, and for Drainage and Sewerage Under Pressure - Polyethylene (PE)
Part 3: Fittings

TS EN 12201-4

Plastic Pipe Systems for Water Supply, and for Drainage and Sewerage Under Pressure - Polyethylene (PE)
Part 4: Valves

TS EN 12201-5

Plastic Pipe Systems for Water Supply, and for Drainage and Sewerage Under Pressure - Polyethylene (PE)
Part 5: Fitness for Purpose of the System

TS CEN/TS 12201-7

Plastic Pipe Systems for Water Supply, and for Drainage and Sewerage Under Pressure - Polyethylene (PE)
Part 7: Guidance for the Assessment of Conformity

DIN 8074

PE Pipes: PE63 , PE80, PE100, PEHD - Dimensions

DIN 8075

PE Pipes: PE63 , PE80, PE100, PEHD - Dimensions
General Quality Requirements, Testing

ISO 4427-1

Plastics Piping Systems - Polyethylene (PE) Pipes and Fittings for Water supply Part 1: General

ISO 4427-2

Plastics Piping Systems - Polyethylene (PE) Pipes and Fittings for Water supply Part 2: Pipes

ISO 4427-3

Plastics Piping Systems - Polyethylene (PE) Pipes and Fittings for Water supply Part 3: Fittings

ISO 4427-5

Plastics Piping Systems - Polyethylene (PE) Pipes and Fittings for Water supply Part 5: Fitness for purpose of the system



TS EN 1555-1

Plastic Pipe Systems - Polyethylene (PE) for Carrying Gas Fuels Section
Part 1: General

TS EN 1555-2

Plastic Pipe Systems - Polyethylene (PE) for Carrying Gas Fuels Section
Part 2: Pipes

TS EN 1555-3

Plastic Pipe Systems - Polyethylene (PE) for Carrying Gas Fuels Section
Part 3: Fittings

TS EN 1555-4

Plastic Pipe Systems - Polyethylene (PE) for Carrying Gas Fuels Section
Part 4: Valves

TS EN 1555-5

Plastic Pipe Systems - Polyethylene (PE) for Carrying Gas Fuels Section
Part5: System Conformity with the Purpose

TSE CEN/TS 1555-7

Plastic Pipe Systems - Polyethylene (PE) for Carrying Gas Fuels Section
Part 7: Compliance Assessment Manual

ISO 4437

Buried Polyethylene (PE) Pipes for the Supply of Gaseous Fuels-Metric Series-Specifications

TS EN 1759-1

Flanges and Connections, Pipes, Valves, Ball Flanges for Fittings and Fixtures - With brief class indication Section
Part 1: Steel Flanges, NPS 1/2 to NPS 24 TS EN 1092-1

TS EN 1092-1

Flanges and Connections, Pipes, Valves, Ball Flanges for Fittings and Fixtures - With brief PN indication Section
Part 1: Steel Flanges



HDPE Cable Duct Pipes

HDPE Cable Duct Pipes

FIRAT Cable Duct Pipes manufactured from HDPE raw material are flexible and lightweight with its double wall corrugated or multi eyed structure. Therefore, they are quick and easy to install.

Areas of Use

- Telecommunication data lines.
- Underground power lines.
- Traffic light signaling lines.
- Traffic MOBESE and radar lines.
- Railway signaling lines.
- All kinds of industrial facility data and power lines.

Benefits

- Easy to ship due to its lightweight, easy to cut and quickly installed.
- Not affected from underground movements since it is flexible.
- Causes no installation wastage. Since short parts can be jointed using Couplers, they can be used without any reduction in cross section.
- Does not break or crack under low ambient temperature.

HDPE Cable Duct Pipe

Used as Cable Duct pipe in telecommunication and power lines. Pipes which are used with the same purpose as PVC Cable Duct pipes are manufactured from high density polyethylene. It is resistant to environmental conditions and flexible in underground applications.

- It is easy to ship and install due to its light weight.
- Can be manufactured in custom lengths such as 8, 10, 12 meters etc.
- It is economical.
- Can be jointed easily with Couplers made of polyethylene.

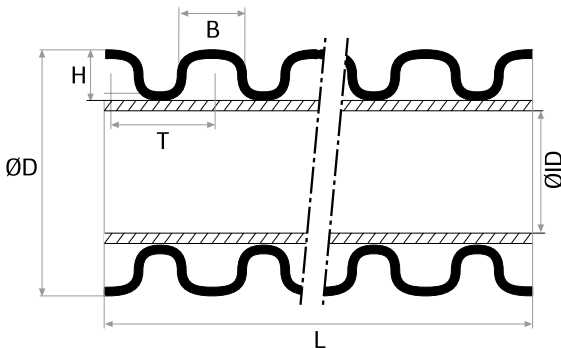

Dimension Information of HDPE Pipes

DN Nominal Diameter/mm	DA mm	DI mm	H mm	T mm	B mm	L mm
75	90	75	6.3	9.9	5.5	6
100	118	100	7.7	11	6.8	6



Triple PE Collector Pipe (Open)

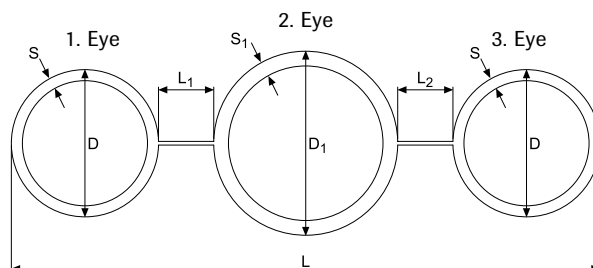

Material: HDPE

1. Eye		2. Eye		3. Eye		L ₁ mm	L ₂ mm	L mm
D	s mm	D ₁	s ₁ mm	D	s mm			
40	3	50	4	40	3	15	15	160

Double PE Collector Pipe

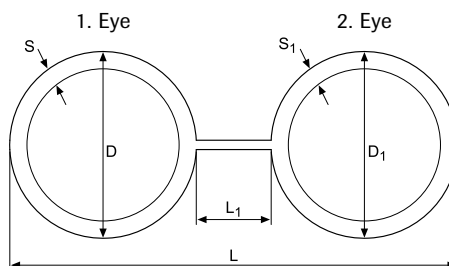

Material: HDPE

1. Eye		2. Eye		L ₁ mm	L mm
D	s mm	D ₁	s ₁ mm		
32	2.0	32	2.0	16	80
40	3.7	40	3.7	16	96

Triple PE Collector Pipe (Closed)

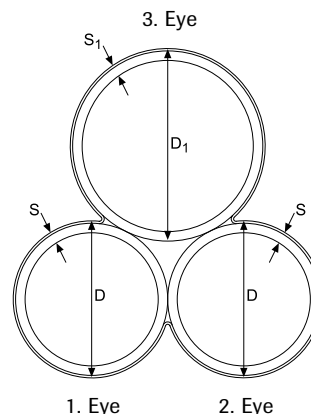

Material: HDPE

I. Eye		II. Eye		III. Eye	
D	s mm	D ₁	s ₁ mm	D ₁	s ₁ mm
32	2.5	32	2.5	40	3.0
40	3.0	40	3.0	50	4.0
32	2.5	32	2.5	50	3.0

HDPE Cable Duct Pipes

Connecting Socket

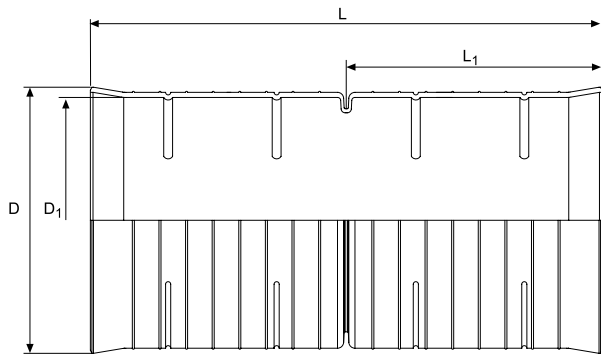

Material: HDPE

DN Nominal Diameter/mm	D mm	D ₁ mm	L mm	L ₁ mm
75	93	102.5	200	170
100	120	129	250	219.5

Adapter

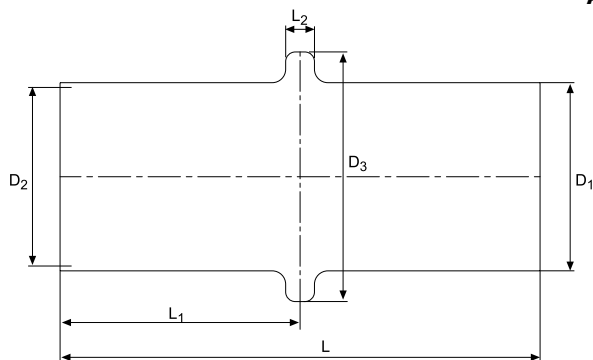

Material: HDPE

DN Nominal Diameter/mm	D ₁ mm	D ₂ mm	D ₃ mm	s mm	L ₁ mm	L ₂ mm	L mm
100	98	93	130	2.5	125	15	250

Detachable Repair Socket

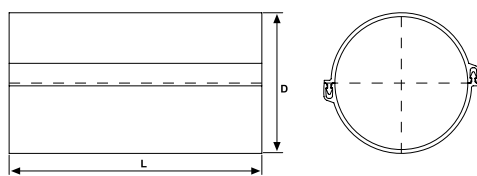

Material: HDPE

DN Nominal Diameter/mm	D mm	D ₁ mm	s mm	L mm
100	106.4	100	3.2	6000

Plug

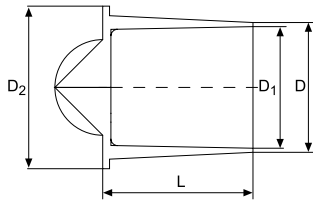

Material: LDPE / HDPE

DN Nominal Diameter/mm	D mm	D_1 mm	D_2 mm	L mm
75	80	70	91	85
100	105	90	119	110

PE Pipe Plug

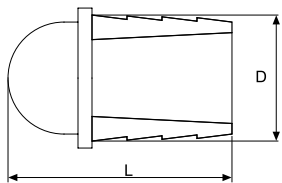

Material: LDPE / PVC (soft)

Outer Diameter mm	L mm
29	64
32.6	64
36	64

Pipe Support

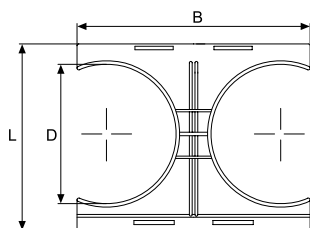

Material: PVC (soft)

Nominal Diameter mm	D mm	L mm	B mm
110	110	150	188

Triple Pipe Wedge

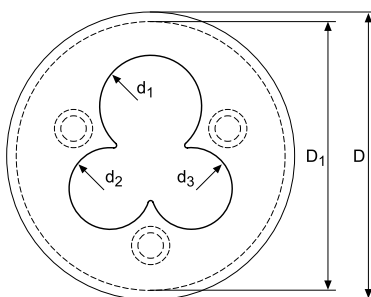

Material: PVC (soft)

Nominal Diameter mm	D mm	D_1 mm	d_1 mm	d_2 mm	L mm	L_1 mm
110	110	100	32.5	40.5	57	50

PE Pipes Application Techniques

Sea Discharge Application with HDPE Pipes

Waste water and sewage lines are discharged to the sea in coastal settlements. Since the seas are being polluted more every other day and aqueous life is being threatened, these settlements shall subject waste waters to treatment process and they shall be discharged to seas upon being rendered harmless for the aqueous life.

In some projects, sewage lines are required to pass through water in areas such as river, lake and swamps. HDPE pipes are the most economical solution with their convenience and permanent durability for such critical area applications. The most ideal pipe for the delivery of waste waters which will be discharged to the sea is HDPE pipe which is not affected by sea water, water movements and ensuring definite leak-proof.

In sea discharge applications, pipes are extended from the final manhole on the shore to the streaming open sea, treated waste water is discharged to the deep stream of the sea. HDPE pipes are submersed on the sea bottom and fixed with concrete blocks since their density is lower than water. Pipes in long discharge lines are jointed on the shore in 250 to 500 m sections and their ends are covered with blind flanges, concrete connections are made and they are conveyed to the application field by floating.

At the application field, floating segments are jointed together at their flanged points from the land. Air inside the floating pipes are displaced with sea water from land to sea in a controlled manner and pipes are submersed on the sea bottom.

In sea discharge lines, end section of the pipe is closed to prevent sedimentation of waste on the mouth of the pipe, diffuser application shall be ensured at the point where the waste is discharged to water to ensure a homogenous distribution. Diffuser outputs shall be realized in an oppositely crosswise fashion on the top 120° circumference of the pipe. Filtered special diffuser application shall be realized in critical projects.

Sea Discharge Drainage Line Application Cross Section

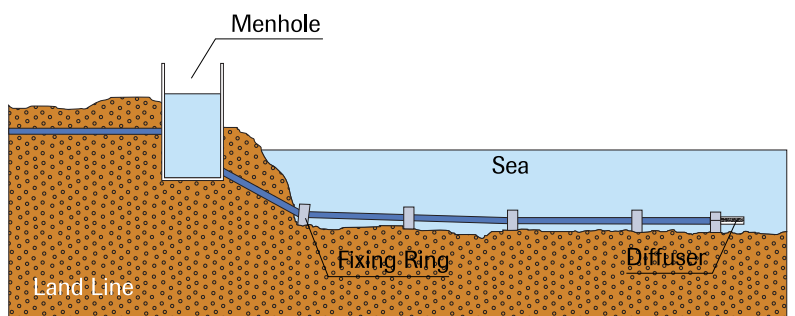

Application of HDPE Pipe in Solid Waste Projects

It is a widely known fact that today industry advances and population increases quickly and gigantic waste mountains are formed by domestic and industrial wastes near settlements. In addition to the threat of these waste dumps on social health, one of the most significant problems is the pollution it causes in underground water resources which diminish every other day.

Today, the healthiest solution which is accepted in modern societies and in our country is to collect these waste dumps in a impermeable landfill, discharging leachate by draining, discharging the methane gas that forms and using it as an energy source upon liquefaction. It is possible to prevent visual pollution by covering the completely full landfills with impermeable soil layer, laying vegetation soil on it and turning them into green fields.

Since solid wastes contain various chemicals, they also cause formation of numerous chemicals continuously through decomposition. This process goes on for extended years. Therefore, the most ideal material which can withstand the load of heavy waste dumps and the effects of the formed chemicals is HDPE piping. Used both for draining leachate and discharging methane gas, HDPE pipes are used safely according to the conditions stipulated by TS 418-2 EN 12201-2 standards.

Installation conditions of pipes which will be used for drainage purposes and operating systems are realized according to DIN 19677, permeability tests and controls are realized according to DIN 4266 standarts.



Solid Waste Landfill Cross Section

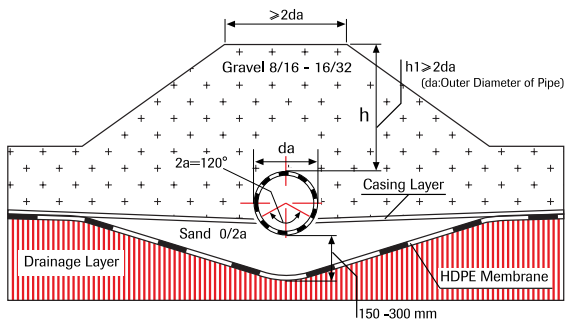
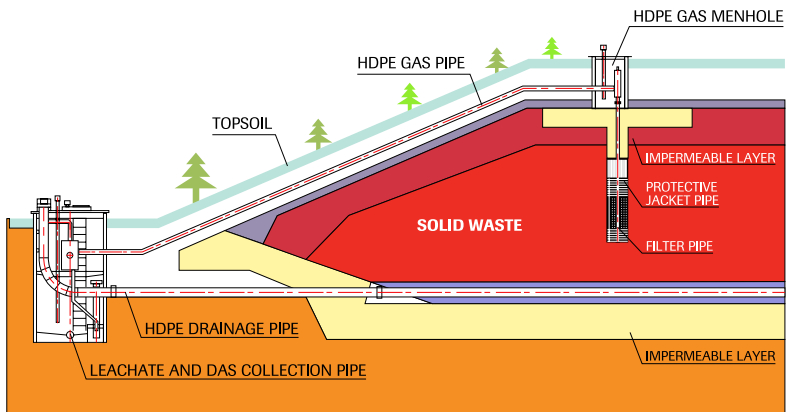

PE Pipes Application Techniques

Relining Application with HDPE Pipes

Infrastructure applications are hard and demanding works. It is always possible to experience challenges which result from uncertainties in the implementation phase. Many times during applications, pipes are required to be laid in confined and closed spaces where it is not possible to carry out open excavation.

Such problems are generally experienced at old settlements where buildings with more floors and occupants are built upon demolishing the current ones without carrying out infrastructure revision. Available infrastructures require renewal since they become useless due to reasons such as collapsing and blocking or due to insufficient capacity.

In such cases, HDPE pipes can be inserted through old lines using relining method. Particularly since they have a very lower friction coefficient compared to other pipes and enables use of one size smaller diameter than the available piping, HDPE pipes can pass through the existent pipes and the problem is solved in a permanent and economical way without requiring extensive excavation work.

In the relining method, a channel is opened at the starting point of the tunnel or pipe which the HDPE pipe will pass through and the fused pipes are inserted in the existent faulty line by continuously pushing and pulling. Here, the most important point is to inspect and clean the interior of existent pipe line and to remove any obstacles inside the pipe before commencing the installation. Upon carrying out the required cleaning, a pulling head is installed on the HDPE pipe and it is pulled in the existent line using various tools, pipe line can be lubricated if required to minimize friction. Upon completion of the pipe pulling process, spacing between the old line and HDPE pipe shall be filled by injecting filler or concrete.

In pipe systems which require installation under existent systems such as highways and railroads or laying a new line with horizontal boring method, firstly steel or concrete pipe is installed at the passage area and HDPE pipes are applied through this pipe using pulling method.



Potable Water Application with HDPE Pipes

Manufactured since 1950s, HDPE pipes have been used increasingly in potable water projects with their corrosion resistance, flexibility and flow rate performances. First potable water applications with HDPE pipes have commenced in America and Canada following 1960s and projects executed at those dates are still operating without any problems.

It is possible to realize connection between all kinds of parts used in potable water lines such as valves, sucking disc, hydrant; and polyethylene pipes in a healthy and convenient way.

Bending diameter of HDPE pipes in pressure potable water lines is about 20 to 50 times of the pipe diameter. Therefore, no fittings are required at wide turns in potable water lines built with HDPE pipes. Since friction coefficient of HDPE pipes is low in pressure potable water lines it is possible to use pipes with one size smaller diameter compared to ductile etc. pipes. On the other hand, HDPE pipes are unquestionably superior pipes since networks established with HDPE pipe ensures definite leak-proof, perfect hygiene, minimum 50 years operating life, no need for maintenance and repair and eliminates large water losses resulting from leaks particularly in city potable water networks.



PE Pipes Application Techniques

Application of HDPE Pipes in Industrial Facilities

HDPE pipes are most ideal pipes particularly for industrial facilities which operate with various chemical fluids due to its high resistance against chemicals and their long life. Particularly in such facilities, production losses due to downtimes and problems cause higher costs compared to the failure and maintenance costs concerning the pipesystem. Therefore, in facilities where hot fluids such as steam is not conveyed, HDPE pipes shall be mainly preferred.

HDPE pipes are compatible to be connected to any type of fittings required by the system and ensure production of any part which requires special design. In particular, tanks and silos designed for storing acid type chemicals and their pipesystems can be



completely made of HDPE, it presents the most ideal solution for such processes with its high resistance to corrosion. HDPE tank and pipesystems with increased UV resistance can be employed outdoors safely.

On the other hand, due to its high friction resistance, conveying of abrasive materials such as ground coal, sludge, sand through HDPE pipes upon being mixed with a certain amount of water is implemented in industrial systems as the most economical and practical application.



PE Pipes Application Techniques

Geothermal Pipe Applications

Geothermal energy is an energy form that is obtained through discharge of hot water from under earth's crust to surface as high temperature steam or hot water.

Geothermal energy is widely used for electricity energy generation, heating residences and meeting hot water demands, heating greenhouses, in hot springs and production of precipitated calcium carbonate.

For conveying geothermal waters from their source to the point of utilization without causing heat loss, pipes with special insulation are employed.

Insulated pipes consist of two overlapping pipe systems as inner conveying pipe and outer jacket pipe that is filled with insulating material.

Conveying pipes are generally PPRC and Pex pipe and high density polyethylene pipes are used as jacket piping. Polyurethane foam prepared with 60 kg/m³ density under 1870 kPa pressure is widely used as insulating material.

Structure of the Geothermal Pipe

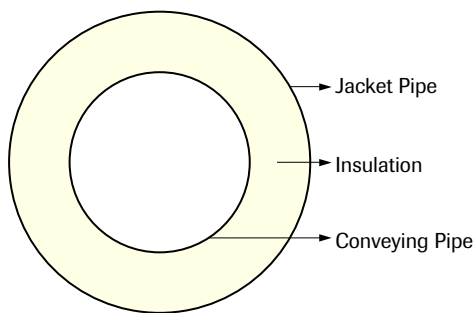

The primary reason for particularly preferring polyethylene pipe as jacket pipe in insulated pipe systems is the high impact resistance of polyethylene pipes and ability to ensure full tightness by preserving its insulating attributes thanks to easy joining and welding; and particularly, its immunity against alkalis and acids in the soil.

Therefore, polyethylene is recommended as the most appropriate material both in national and international applications and standards.

Pre-Insulated Pipe Calculation Table TS EN 253

STEEL PIPE NOMINAL DIAMETER		PRODUCT NAME	STEEL PIPE			HDPE JACKET PIPE			INSULATION (PUR) THICKNESS
DN	INCH		Outer Diameter mm	Minimum Wall Thickness mm	Internal Diameter mm	Outer Diameter mm	Minimum Wall Thickness mm	Internal Diameter mm	mm
Ø15	1/2"	15mm Pre-Insulated Pipe	21,30	2,00	17,30	75	3,00	69,00	23,85
Ø20	3/4"	15mm Pre-Insulated Pipe	26,90	2,00	22,90	90	3,00	84,00	28,55
Ø25	1"	15mm Pre-Insulated Pipe	33,70	2,30	29,10	90	3,00	84,00	25,15
Ø32	1 1/4"	15mm Pre-Insulated Pipe	42,40	2,60	37,20	110	3,00	104,00	30,80
Ø40	1 1/2"	15mm Pre-Insulated Pipe	48,30	2,60	43,10	110	3,00	104,00	27,85
Ø50	2"	15mm Pre-Insulated Pipe	60,30	2,90	54,50	125	3,00	119,00	29,35
Ø65	2 1/2"	15mm Pre-Insulated Pipe	76,10	2,90	70,30	140	3,00	134,00	28,95
Ø80	3"	15mm Pre-Insulated Pipe	88,90	3,20	82,50	160	3,00	154,00	32,55
Ø100	4"	15mm Pre-Insulated Pipe	114,30	3,60	107,10	200	3,20	193,60	39,65
Ø125	5"	15mm Pre-Insulated Pipe	139,70	3,60	132,50	225	3,40	218,20	39,25
Ø150	6"	15mm Pre-Insulated Pipe	165,10	4,00	157,10	250	3,60	242,80	38,85
Ø200	8"	15mm Pre-Insulated Pipe	219,10	4,50	210,10	315	4,10	306,80	43,85
Ø250	10"	15mm Pre-Insulated Pipe	273,00	5,00	263,00	400	4,80	390,40	58,70
Ø300	12"	15mm Pre-Insulated Pipe	323,90	5,60	312,70	450	5,20	439,60	57,85
Ø350	14"	15mm Pre-Insulated Pipe	355,60	5,60	344,40	500	5,60	488,80	66,60
Ø400	16"	15mm Pre-Insulated Pipe	406,40	6,30	393,80	560	6,00	548,00	70,80
Ø450	18"	15mm Pre-Insulated Pipe	457,20	6,30	444,60	630	6,60	616,80	79,80
Ø500	20"	15mm Pre-Insulated Pipe	508,80	6,30	496,20	710	7,20	695,60	93,40
Ø550	22"	15mm Pre-Insulated Pipe	558,80	6,30	546,20	710	7,20	695,60	68,40
Ø600	24"	15mm Pre-Insulated Pipe	609,60	7,10	595,40	800	7,90	784,20	87,30
Ø700	28"	15mm Pre-Insulated Pipe	711,20	8,00	695,20	900	8,70	882,60	85,70
Ø800	32"	15mm Pre-Insulated Pipe	812,80	8,80	795,20	1000	9,40	981,20	84,20
Ø900	36"	15mm Pre-Insulated Pipe	914,00	10,00	894,00	1200	11,00	1178,00	132,00
Ø1000	40"	15mm Pre-Insulated Pipe	1016,00	11,00	994,00	1200	11,00	1178,00	81,00
Ø1100	44"	15mm Pre-Insulated Pipe	1117,60	11,00	1095,60	1400	12,50	1375,00	128,70
Ø1200	48"	15mm Pre-Insulated Pipe	1219,20	12,50	1194,20	1400	12,50	1375,00	77,90

PE Pipes Application Techniques



Waste Water Treatment Plant Applications with HDPE Pipes

In parallel with the advancing technology, concentration of chemical wastes such as detergent etc. in municipal waste waters in addition to sewage, quick destructing effect of industrial chemical waste waters on the nature have made establishment of waste water treatment plants necessary today as a complementary system to sewage systems.

Treatment plants have a major importance in terms of protecting natural resources and human health.

Both industrial waste waters and municipal waste waters are required to be subjected to biological or chemical treatment process.

Industrial and domestic waste waters possess numerous chemical and physical properties. Both due to unique structure of waste water and chemicals employed in treatment process, HDPE pipes have become the most suitable solution for waste water treatment systems thanks to their resistance to chemicals, abrasion and corrosion and their ultimate tightness.

HDPE pipes are very useful in connections between neutralization, stabilization, aeration and sedimentation pools both due to their ease of operation and installation compatibility they have with any kind of connection required by the system.

Since waste lumps generated during treatment process do not cause clogging of HDPE pipes, failures in the system arising from such reason are avoided. Strength and smoothness attributes of HDPE pipes for conveying particles precipitated in sedimentation pools to sludge-elimination unit, render these pipes the most ideal pipesystem for the system.

HDPE pipes are used successfully in collector line and for conveying the treated water to discharge point.



Natural Gas Network Applications with HDPE Pipes

Natural gas networks are networks which require extensive care and precision in application. Therefore, pipes are required to have high resistance against chemicals in the soil and adverse underground conditions. While polyethylene coated steel pipes are preferred as high pressure main conveying pipes in application, high density PE 80 or PE 100 pipes and fittings are always preferred for intra-city distributions.

Pressure of which is reduced to 4 bars by the pressure reduction regulators, intra-city distribution of natural gas is always realized with polyethylene pipes. Since polyethylene pipes have very high elongation coefficients and a flexible structure, since they are not affected by seismic movements of soil such as earthquake and since they ensure absolute tightness due to joining with welding method they mainly preferred in distribution networks.

While the pressure of natural gas distributed in city networks is as low as 4 bar, safety coefficient is kept high and SDR 11 pipes with thick walls are used equivalent to 12.5 or 16 bars according to PE classification. On the other hand, polyethylene pipes used in natural gas networks are always jointed with high-safety electrofusion fittings and special steel transition parts.



PE Pipes Application Techniques

Fish Farm Applications



Building cages with UV added high density polyethylene pipes in fish farms which have being developed recently, became widespread.

Polyethylene pipes are used as the most ideal product for such projects since their specific density is lower than water and they have a flexible structure, are resistant to impact, not affected by salty water, chemicals and sun rays, have high strength against wave movements occurring on the sea surface and oceanographic conditions.

In cage applications, HDPE pipes between diameters of 100 mm and 500 mm are mainly used and PE 63 and PE 80 materials are preferred according to the pipe diameter. Pipes can be filled with styrofoam to increase strength of pipes and as a precaution for punctures.

Fish cages can be built in diameters from 10 m to 50 m, generally, inner and outer floating pipe with equal diameters are used, a third safety pipe with small diameter for walking is fitted in the middle of that, safety pipes connected to the inner floating pipe from top with posts and cage construction is completed.



FIRAT sells to a lot of Countries in Europe, America, Asia and Africa

Countries to which FIRAT Exports:

- Afghanistan
- Algeria
- Armenia
- Azerbaijan
- Bahrain
- Belarus
- Belgium
- Bosnia
- Brazil
- Britain
- Bulgaria
- China
- Croatia
- Cyprus
- Egypt
- Ethiopia
- Finland
- France
- Gabon
- Gambia
- Georgia
- Germany
- Ghana
- Greece
- Hungary
- Iceland
- India
- Iranian
- Iraq
- Italy
- Jordan
- Kazakhstan
- Kenya
- Kirghizistan
- Kosovo
- Kuwait
- Latvia
- Lebanon
- Libya
- Macedonia
- Moldova
- Mongolia
- Montenegro
- Morocco
- Netherlands
- New Zeland
- Nigeria
- Pakistan
- Poland
- Portugal
- Romania
- Russia
- Saudi Arabia
- Serbia
- Slovenia
- South Africa
- Spain
- Sri Lanka
- Sudan
- Surinam
- Swedish
- Syria
- Tajikistan
- Train
- Tunisian
- Turkmenistan
- Ukraine
- United Arab Emirates
- Uzbekistan
- Venezuelan
- Yemen



FIRAT

Türkoba Mahallesi

Firat Plastik Caddesi No:23

34537 Büyükçekmece İstanbul / TURKEY

T: +90 (212) 866 41 41 - 866 42 42

F: +90 (212) 859 04 00 - 859 05 00

firat.com

 /firatplastik

 /firatplastik

 /firatplastik

firat@firat.com

info@firat.com